

Report

Conditions for Nordic harmonisation of fire classification of cables

Proposal of implementation of the new European classification system in the building regulations.

Authors

Anne Steen-Hansen, Karolina Storesund, Michael Försth, Michael Strömgren, Brian V. Jensen, Dan Bluhme

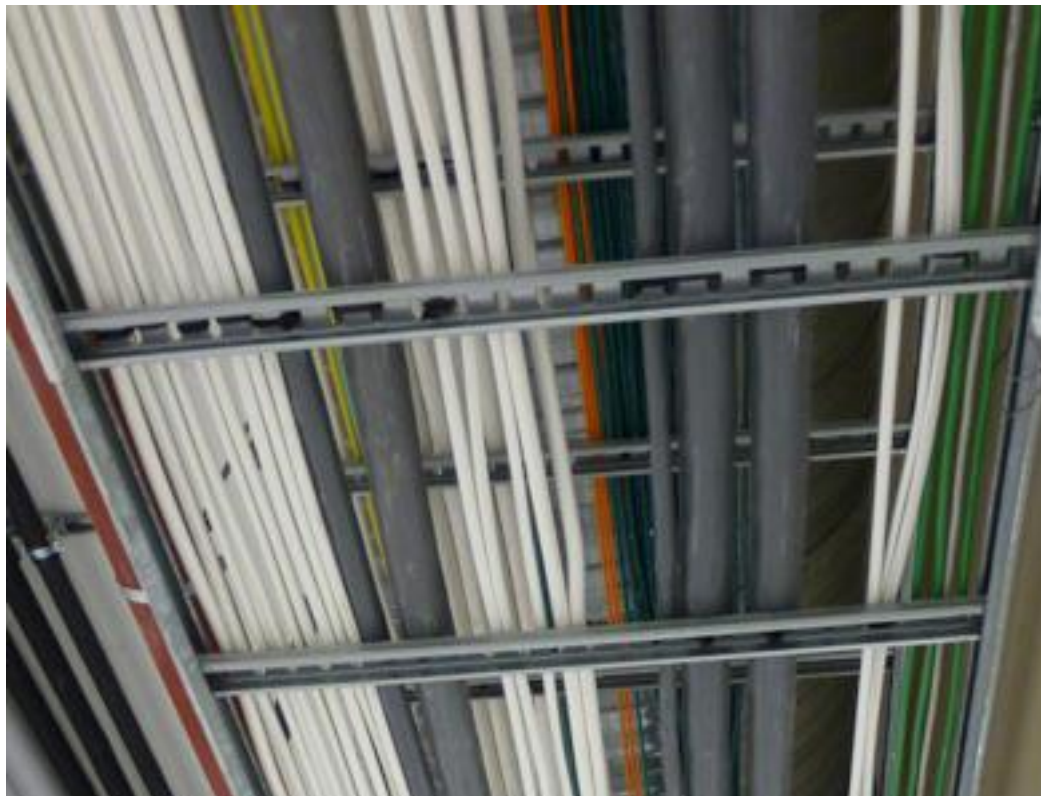

SINTEF NBL as
SINTEF NBL as

Address:
Postboks 4767 Sluppen
NO-7465 Trondheim
NORWAY

Telephone: +47 73591078
Telefax: +47 73591044

nbl@nbl.sintef.no
www.nbl.sintef.no
Enterprise /VAT No:
NO 982 930 057 MVA

Report

Conditions for Nordic harmonisation of fire classification of cables

Proposal of implementation of the new European classification system in the building regulations.

KEYWORDS:

Fire
Safety
Cables
Regulations
Reaction to fire

VERSION

1.1

DATE

2013-06-06

AUTHORS

Anne Steen-Hansen, Karolina Storesund, Michael Försth, Michael Strömgren,
Brian V. Jensen, Dan Bluhme

CLIENTS

The Nordic building authorities, represented by the
Norwegian Building Authority (DiBK)

CLIENT'S REF.

Trond S. Andersen

PROJECT NO.

107583

NUMBER OF PAGES/APPENDICES:

46 + 2 Appendices

ABSTRACT

This report has been prepared for the building authorities in Denmark, Sweden and Norway in cooperation between the fire laboratories in Denmark, Sweden and Norway.

The report gives an overview over fire safety requirements to cables in the present Nordic building regulations and in the Nordic regulations for electric installations. Available information on which classes the most used cables will satisfy in the new system is also presented.

A proposal of how the new European system of reaction to fire classes for electric cables can be implemented in the Nordic building regulations has been developed,

PREPARED BY

Anne Steen-Hansen (SINTEF NBL)

SIGNATURE



CHECKED BY

Björn Sundström (SP Fire Technology)

SIGNATURE



APPROVED BY

Are W. Brandt (SINTEF NBL)

SIGNATURE



REPORT NO.

NBL A13111

ISBN

978-82-14-00120-4

CLASSIFICATION

Unrestricted

CLASSIFICATION THIS PAGE

Unrestricted

Document history

| VERSION | DATE | VERSION DESCRIPTION |
|----------------|-------------|---|
| 1.0 | 2013-05-31 | First version of the report delivered to the clients. |
| 1.1 | 2013-06-06 | The reference to the clients is corrected to include only the building authorities from Denmark, Sweden and Norway. |

Table of contents

| | |
|--|-----------|
| Summary and conclusions | 5 |
| 1 Introduction | 6 |
| 1.1 Background | 6 |
| 1.2 Goal | 6 |
| 1.3 Methods..... | 7 |
| 2 Fire properties for cables – a review..... | 8 |
| 3 Fire statistics and experience from fires | 13 |
| 3.1 Fire statistics in Denmark..... | 13 |
| 3.2 Fire statistics in Norway..... | 14 |
| 3.3 Fire statistics in Sweden..... | 16 |
| 3.4 Finnish data..... | 17 |
| 3.5 Summary of statistical data | 17 |
| 3.6 Reported fires with cables involved..... | 18 |
| 3.6.1 Cable fire in Oslo Central Station, Norway, 2007 | 18 |
| 3.6.2 Fire in a nursing home in Harstad, Norway, 2001 | 18 |
| 3.6.3 Fire in Frogner telephone central, Oslo, Norway, 1986 | 18 |
| 3.6.4 Fire in Rockefeller Center, New York, USA, 1996 | 18 |
| 3.6.5 Fire in an ilmenite smelting plant in Tyssedal, Norway, 1988..... | 19 |
| 3.6.6 Fire in a paper mill in Obbola, Sweden, 2007 | 19 |
| 3.6.7 Summary of reported fires in cables | 19 |
| 4 Regulation of fire properties of cables in the EU | 20 |
| 4.1 The Construction Products Directive | 20 |
| 4.2 The Low Voltage Directive | 21 |
| 4.3 The system of euroclasses for cables..... | 21 |
| 5 Which fire classes do cables in the Nordic countries satisfy today? | 23 |
| 5.1 European cables in the CEMAC-project | 23 |
| 5.2 Cables in Denmark | 24 |
| 5.3 Cables in Norway | 24 |
| 5.4 Cables in Sweden | 24 |
| 6 Regulation of reaction to fire properties of cables | 25 |
| 6.1 Regulations in Denmark..... | 25 |
| 6.1.1 Building regulations in Denmark | 25 |

| | | |
|----------|--|-----------|
| 6.1.2 | Regulations of electric installations in Denmark | 25 |
| 6.2 | Regulations in Finland | 26 |
| 6.2.1 | Building regulations in Finland | 26 |
| 6.2.2 | Regulations of electric installations in Finland | 27 |
| 6.3 | Regulations in Iceland | 28 |
| 6.3.1 | Building regulations in Iceland..... | 28 |
| 6.3.2 | Regulations of electric installations in Iceland | 28 |
| 6.4 | Regulations in Norway | 29 |
| 6.4.1 | Building regulations in Norway..... | 29 |
| 6.4.2 | Regulations for electric installations in Norway | 30 |
| 6.5 | Regulations in Sweden | 33 |
| 6.5.1 | Building regulations in Sweden | 33 |
| 6.5.2 | Regulations of electric installations in Sweden | 33 |
| 6.6 | Similarities and differences between regulations in the Nordic countries | 34 |
| 6.6.1 | Building regulations | 34 |
| 6.6.2 | Regulation of electric installations | 34 |
| 7 | How may reaction to fire properties of cables be regulated? | 35 |
| 7.1 | General principles | 35 |
| 7.2 | Requirements to cables vs requirements to linear products | 35 |
| 7.3 | Proposal of an exception rule for smaller surface areas of electric cables | 37 |
| 7.3.1 | Reaction to fire requirements in special spaces and when other products are involved | 40 |
| 7.4 | Proposal of classes to be used in the Nordic countries | 40 |
| 8 | Discussion | 42 |
| 8.1 | Current regulations in the Nordic countries..... | 42 |
| 8.2 | Fire statistics and experience..... | 42 |
| 8.3 | Proposal of implementation of the cable classes | 43 |
| 8.4 | Further research | 43 |
| | References..... | 44 |

APPENDICES
Appendix A: Classification of cables on the Norwegian market
Appendix B: Estimation of the exposed surface area of cables

Summary and conclusions

This report has been prepared for the building authorities in Denmark, Sweden and Norway in cooperation between the fire laboratories in Denmark, Sweden and Norway.

The main goal of the project has been to propose how the new European system of reaction to fire classes for electric cables can be implemented in the Nordic building regulations. This has been approached by exploring the present fire safety status regarding electric cables in the Nordic countries based on different activities.

The report gives an overview over fire safety requirements that must be met by cables in the present Nordic building regulations and in the Nordic regulations for electric installations, and available information on which classes the most used cables will satisfy in the new system.

Statistics and experience from fires where cables have been involved in the fire development are also presented.

Based on this background, the following proposal of how the euroclass-system for electric cables can be implemented in Nordic building regulations is given:

Electric cables in buildings shall at least fulfill class E_{ca} .

For cables that may be exposed to external fire, we propose that the additional requirements in the following table apply:

| Exposed area of cable surface | General requirement | One- and two story individual dwelling houses | Escape routes for all occupancies |
|-------------------------------|---------------------|---|-----------------------------------|
| $> X^* \%$ | $D_{ca-s2,d2}$ | E_{ca} | $C_{ca-s1,d1}^{**}$ |
| $< X^* \%$ | | | $D_{ca-s2,d2}$ |

* The percentage number X should be set in the range of 2-10 % and be calculated as the exposed area of cables in relation to the area of the ceiling. Some calculation examples are shown in Appendix B.

**This requirement applies only to the part of the exposed area that exceeds X%.

For spaces equipped with a fire alarm or an automatic fire suppression system, a cable class of one step lower than the required class may be used, i.e. E_{ca} instead of $D_{ca-s2,d2}$ or $D_{ca-s2,d2}$ instead of $C_{ca-s1,d1}$.

1 Introduction

1.1 Background

This report is developed within a project for the Nordic building authorities:

- Danish Energy Agency (Energistyrelsen)
- Finland: Ministry of the Environment (Miljöministeriet)
- Norwegian Building Authority (Direktoratet for byggkvalitet - DiBK)
- Iceland Fire Authority (Brunamálastofnun)
- The Swedish National Board of Housing, Building and Planning (Boverket)

The main contact for the clients has been the Norwegian Building Authority. The project work is performed during the spring 2013 in cooperation between the Danish Institute of Fire and Security Technology (DBI), SP Fire Technology in Sweden, and SINTEF NBL (Norwegian Fire Research Laboratory) in Norway.

The background for the project is that fire properties of cables in buildings are regulated by the Construction Products Directive (CPD), and a new system for testing and classification of reaction-to-fire properties of cables has been developed to fulfil this need, and to facilitate the CE-marking of these products. The classification system gives the possibility of defining 183 different classes, when all combinations of euroclasses for heat release and flame spread, and subclassifications for smoke, burning droplets and acidity are considered.

None of the Nordic countries has yet implemented the system of euroclasses for cables in their building regulations. It is therefore a desire to harmonise the application of these classes in the Nordic countries, and to select a minimum of classes that are necessary to cover the present needs. A general goal is to maintain today's fire safety level without increasing costs, and that cables that are used in Nordic buildings today still should be acceptable. However, there may be applications that may lead to higher requirements.

1.2 Goal

The goal of this project is divided into several single objectives, according to the clients' description:

1. To review state-of-the-art for reaction to fire properties for electric cables.
2. To give an overview over fire safety requirements to cables in the present Nordic building regulations and in the Nordic regulations for electric installations, and how these requirements correspond to the new European classification system.
3. To give an overview over which classes cables in the present Nordic market obtain in the new European classification system. Both electric cables and signal- and data cables shall be included in the overview.
4. Based on statistics or experience: Give an assessment if there is a need for different fire requirements of cables in different activities and installations.
5. To give an proposal of 3-4 different reaction-to-fire classes for cables that can be used in the Nordic building regulations in the Nordic countries, and also a guidance for different situations and activities where these classes should be required.
6. To give an overview over statistics and experience from fires where cables have been involved in the fire development.

1.3 Methods

The project is based on collection, assessment and presentation of available information and knowledge. Each project participant has been responsible for collecting and presenting information from their own country. In addition, SINTEF NBL has collected brief information from Finland and Iceland, that did not participate in the project.

SP Fire Technology had the main responsibility for presenting relevant information from the European projects FIPEC [1] and CEMAC [2], since they had a leading role in these projects, and in the development of the new reaction-to-fire classification system for cables.

The relevant information and possible strategies for a solution has been discussed in project meetings. A workshop with the project group and representatives for the building authorities and authorities for electric installations was arranged to exchange information and discuss preliminary conclusions.

2 Fire properties for cables – a review

The major causes for ignition of cables has been summarised by Babrauskas [3, 4], who also presents an extensive review of the mechanisms:

- arcing
- excessive ohmic heating, without arcing
- external heat sources

Babrauskas [5] and Stricker [6] analysed thermal and ignition properties of PVC cables in depth and found that standard temperature cables that are rated for 90 °C or 105 °C should not be operated over 71 °C due to aging through loss of plasticisers. Furthermore, PVC cables with CaCO₃ fillers have a unique failure mode, wet arc tracking under initially dry conditions [7]. If arcing occurs such that a carbonised path is created between two conductors this is termed arc tracking. Wet arc tracking is arc tracking with moisture involved and typically requires lower temperatures than dry arc tracking. With CaCO₃ present wet arc tracking can occur also without initial moisture since a wet film can be produced by the filler. This illustrates the complexity in ignition of cables. As will be seen below, the subsequent cable fire (after ignition) is also a complex phenomenon where the available information is of little generic validity, but mostly empirical case-dependent data.

The understanding of reaction to fire properties, especially flame spread, of cables is relatively poor due to the complex geometry as compared to e.g. vertically oriented flat surfaces [8-12]. Therefore a well defined standard for assessing the fire performance in an objective way is of especially high importance for cables.

A major study of the reaction to fire properties of cables was performed within the EU-funded FIPEC-project (Fire Performance of Electric Cables) [1]. The main purpose of the project was to develop a test method, based on a combination of the IEC 60332-3 test standard complemented with modern fire measurement technology. An outline of the IEC 60332-3-10 test apparatus is shown in Figure 2-1.

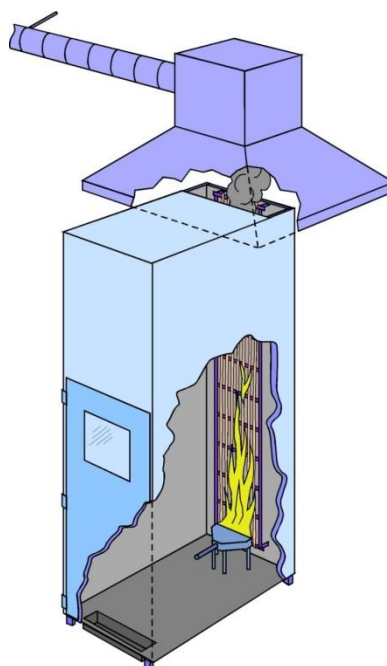

Figure 2-1 Outline of the IEC 60332-3-10 test apparatus.

The proposed test should be capable of efficiently assessing the fire performance of cables in a way that is representative for real fires. In order to do so, two reference scenarios were first defined. These are shown in Figure 2-2 and Figure 2-3.

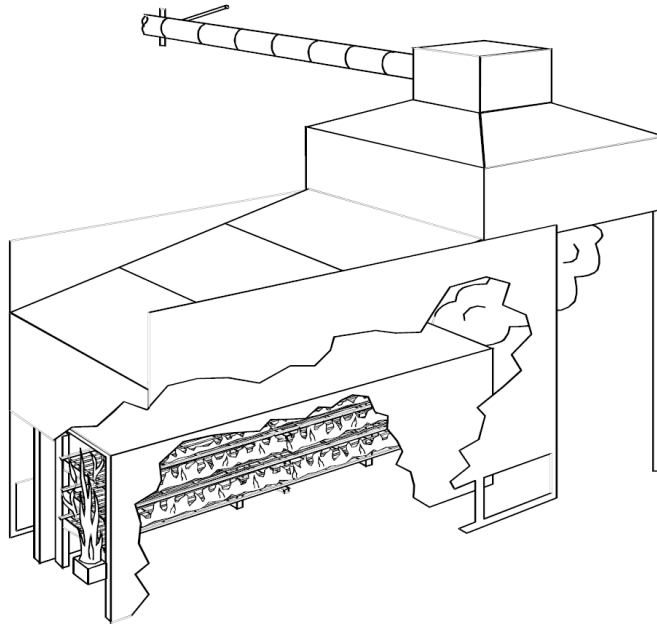

Figure 2-2 Horizontal reference scenario in the FIPEC project [1].

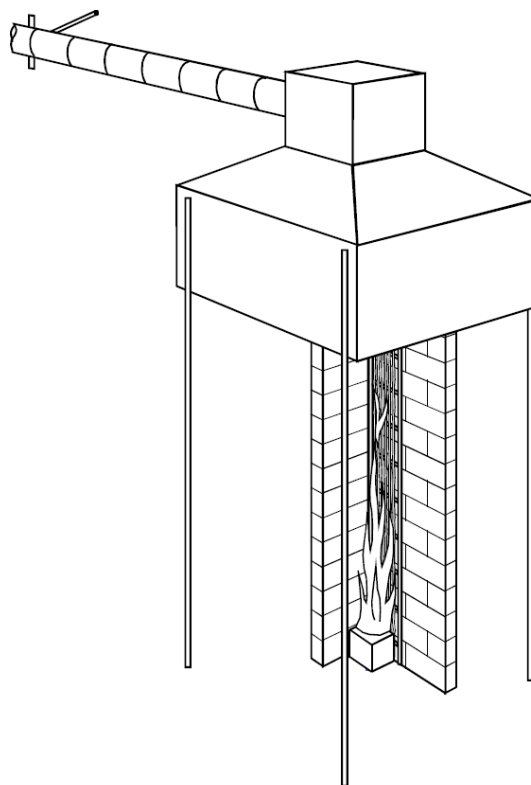

Figure 2-3 Vertical reference scenario in the FIPEC project [1].

10 identified real scale scenarios were considered, and it was found that the reference scenarios in Figure 2-2 and Figure 2-3 were the most efficient in differentiating cable fire performance. The reference scenarios were determined together with industrial partners and were considered as good representations for real scale scenarios, e.g. for power plants, tunnels and occupancies. Details about the two selected reference scenarios can be found in the FIPEC report [1]. Testing against the reference scenarios is not done frequently due to the high cost involved, and therefore a new test method based on the IEC 60332-3-10 should be developed. In order to do so an extensive test campaign (test data from almost 2000 experiments are held in the FIPEC database) was performed with real scale tests and with different protocols for testing in the IEC 60332-3-10 apparatus. Parameters that were studied for the protocols were e.g. type of burner (premixed or diffusion), burner power, test duration, and mounting procedures for cables on the ladder. The report concludes that a test duration of 20 minutes with a 20.5 kW premixed burner flame are appropriate parameters for most cables. Maybe more important was the finding of which mounting procedures that gives the most appropriate test. It was found that for cables with a diameter larger or equal to 20 mm there should be a 20 mm spacing between the cables on the ladder. For cable diameters between 5 mm and 20 mm the spacing should be one cable diameter. And for cable diameters less than 5 mm the cables should be collected into bundles of 10 mm diameter with 10 mm spacing between bundles. The proposal from the FIPEC project is the basis for the latest revision of the EN 50399 standard [13, 14].

The complexity of fire behaviour of cables became evident in a recent project called CEMAC (CE-marking of electric cables) [2] where the main purpose was to propose EXAP rules (Extended application) for cables tested according to the EN 50399 standard.

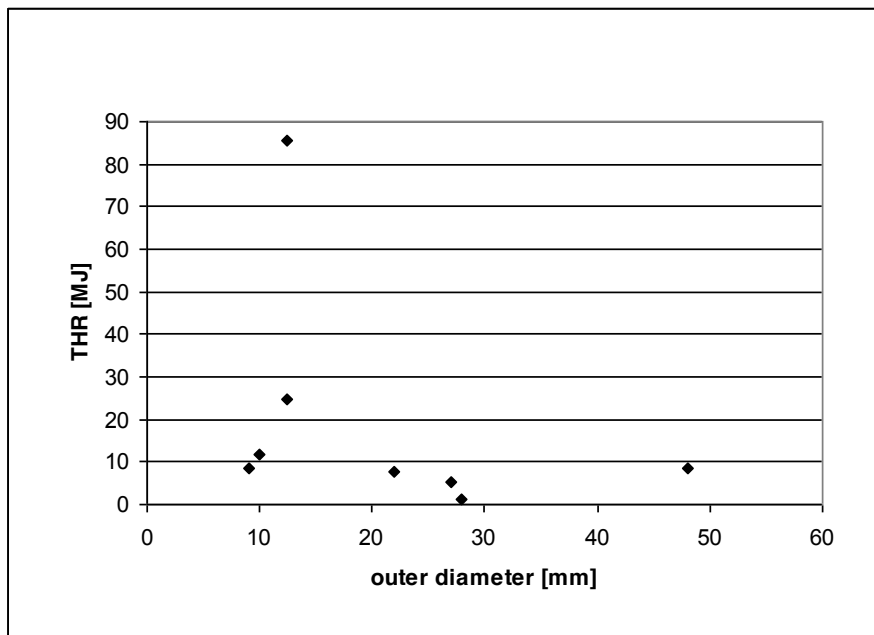

Figure 2-4 Total heat release in the EN 50399 test for unarmoured multicore cables of different diameters.

The cables in Figure 2-4 are all from a product family of unarmoured multicore cables. The cables were tested according to the standard EN 50399 [13]. From the figure it is evident that even cables from a well defined family (different diameters and different number of conductors, but same sheathing and insulation materials) can exhibit a very unpredictable behaviour. A plausible suggestion for explanation of the irregular behaviour in Figure 2-4 was that the outlier had 7 conductors of relatively small cross section, 1.5 mm², each. The other cables had either only two conductors of the same cross section or several (maximum 5)

conductors of larger cross section. In general, cables with smaller diameters (or conductor cross sections) exhibit a worse fire performance than larger cables due to the more rapid heating of small cables. Therefore, once the sheathing of a cable with many conductors is broken due to the fire, all individual conductors are exposed to the fire, and this results in a scenario similar to fire testing of many smaller cables. In brief, the example above illustrates the complexity in reaction to fire of cables.

Breulet and Steenhuizen [15] compared cable testing in the SBI-test (EN 13823 Single Burning Item) as compared to the geometry of the EN 50399 test, shown in Figure 2-1. The SBI is used within the construction products directive, CPD, for testing construction products like linings, panels and pipe insulation. It was found that both methods have their own merits, but a major drawback for the SBI is that the possibility to measure flame spread is very limited.

Mangs and Hostikka [16] investigated the influence of the ambient temperature on the vertical flame spread on two different 2 m long single mounted PVC-cables. It was found that the flame spread rate increases roughly exponentially with ambient temperature. The flame spread increased from 3 mms^{-1} at $23 \text{ }^\circ\text{C}$ to 24 mms^{-1} at $190 \text{ }^\circ\text{C}$. At high temperatures both cables were burning simultaneously over their total length, that is the flame spread had reached the upper end before extinction started at the lower end. This obviously has severe effects on the peak heat release rate. There were no clear differences in the flame spread for the two cables (13 mm outer diameter with $4 \times 15 \text{ mm}^2$ conductors, and 18.5 mm outer diameter with $4 \times 6 \text{ mm}^2$ conductors).

In the project CHRISTIFIRE (Cable heat release, ignition, and spread in tray installations during fire) reaction to fire properties of cables in horizontal trays were investigated. The project was financed by the U.S. Office of Nuclear Regulatory Research with the purpose of obtaining quantitative data of fire properties of grouped cables typically used in nuclear power plants. A general conclusion was that the variability in cable constructions made it difficult to create a database which describes the fire performance of cables in a meaningful way. Measurements using the ISO 5660 cone calorimeter method show that typical heat release rates were in the range $100\text{-}200 \text{ kWm}^{-2}$ for thermoset cables (cables that do not melt) while the range was $200\text{-}300 \text{ kWm}^{-2}$ for thermoplastic cables (cables that can melt). However, it should be kept in mind that these results are obtained for a test method where the entire cables are exposed to an external heat source. In flame spread tests, where the flame is self-propagating and not driven by an external heat source, it was found that some cables propagated the fire to a very limited extent whereas other cables propagated the fire to the end of the trays. The flame spread rate for the fully combusted cables were however within the recommendations in NUREG/CR-6850, which is 0.3 mms^{-1} for thermoset cables and 0.9 mms^{-1} for thermoplastic cables [17]. NUREG/CR-6850 contains a methodology for the U.S. nuclear industry for fire probabilistic assessment (fire PRA). Cone calorimeter reaction to fire data for cables has also been reported by for example Rao et al. [18] and Steen-Hansen et al. [19]. The latter report also studies the effect of ageing on the reaction to fire performance of cables. No significant effects due to ageing could be observed.

Passalacqua et al. [20] investigated the fire performance of 3 power cables and one control cable as part of ensuring fire safety in the ITER project. Although the investigated cables were all of a relatively good fire quality they were completely combusted when grouped on ladders oriented vertically, using 28 kW and 85 kW burner powers. The flame spread was estimated to $10\text{-}13 \text{ mms}^{-1}$ based on temperature data from thermocouples mounted on the surface of the cables. By contrast, 3 cables were also tested in horizontal configuration and they extinguished quickly once the burner (85 kW) was removed.

Alvares and Fernandez-Pello [21] analysed a fire in a telephone exchange central that occurred in Hinsdale, USA, in 1988 [22]. Based on the reported fire damage signature combined with experimentally measured fire data for cables [23, 24] the authors modeled fire characteristics such as heat release rates, smoke and HCl generation, smoke layer including smoke and HCl concentrations, smoke detector activation and sprinkler actuation. An interesting observation was that, based on this particular study, the destruction of electric

components due to the corrosive smoke could be worse than the destruction due to water from sprinklers. This contradicts the claim that the damage due to water from sprinklers can be worse than the fire itself.

Several other works has been presented on the issue of fire smoke and electronics, see for example the reported work from Isaksson [25] and from Peacock [26]. Measurement issues for correct classification of cables based on their production of obscuring smoke was discussed by Breulet [27].

3 Fire statistics and experience from fires

For the project fire statistics concerning electrical causes from Denmark, Norway and Sweden have been available, in addition to one paper presenting Finnish data. There is no available statistics that give information on how different building materials, including cable insulation, have contributed to the fire development. Such information may be found in reports from fire investigations, if this has been focused by the investigator. Information may also be found in reports in media, this information is however, generally not specific enough or reliable enough to give us a picture of the fire safety connected to cables in buildings.

3.1 Fire statistics in Denmark

A Danish report from Sikkerhedsstyrelsen (the Danish Safety Technology Authority) contains information about registered fires with electric cause in the period 2001-2010 [28]. The report also contains information on the fire sources (the apparatus or component where the fire started). The report gives detailed information on 316 fires out of 1833 fires with electric cause in 2010. According to the report, there were 16 723 fires in Denmark in 2010, it is not stated if this number also includes other fires than building fires.

The trend in registered electrical fires from Sikkerhedsstyrelsen is shown in Figure 3-1.

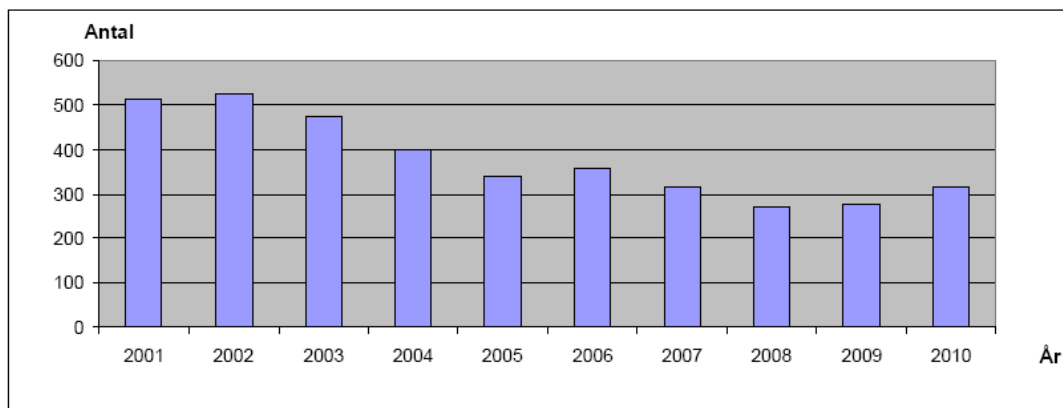

Figure 3-1 Number of registered fires with electric cause in Denmark during the period 2001 to 2010 [28].

Of the 316 investigated fires with electric cause, 36 % started in installations, and 4 % in power supply.

The fires in electric installations were distributed as shown in Figure 3-2. The figure shows that approximately 50 % of these fires were found to have started in cables or installation wiring. If we assume that the distribution of fires in installations for the fires that not were investigated is the same as in this figure, that means that approximately 660 fires started in installations, and approximately 330 started in cables or installation wiring. This number amounts to about 2 % of all the 16 273 fires.

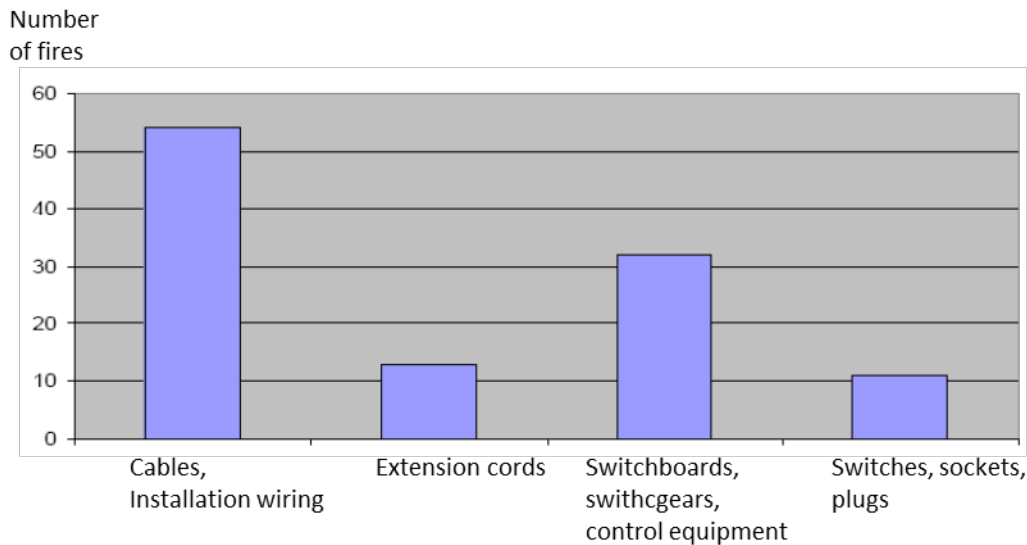

Figure 3-2 110 Danish fires that started in electric installations distributed on different electric components. The categories are translated into English from [28].

3.2 Fire statistics in Norway

The Norwegian directorate for Civil Protection and Emergency Planning (DSB) is responsible for collecting fire statistics in Norway. DSB yearly publishes a summary of which electrical appliances and type of electrical material where the fires with electrical causes have started. The information in this section is collected from a report on fires with electrical cause in Norwegian residential buildings in the period 1995-2005 [29] with more recent data included in a report on fire properties of electric cables from 2012 [19].

In the study covering the time period 1995-2007, it was concluded that while the number of fires that started in domestic appliances was reduced to almost the half during the period, the number of fires caused by electric installation materials (cables, sockets, terminal boxes, power switches, etc.) was increasing [29]. The number of fires in the subcategory cables increased from 21 in 1995 to 40 in 2009.

Figure 3-3 shows the development in the number of fires in installation materials. The annual number of fires in installation materials has increased from approximately 60 fires in 1995 to 150 fires in 2009, i.e. the number of fires has doubled over 15 years.

Fires caused by faults in electric installation material amounted on average to 23 % of the residential fires with electric fire cause over the 15 year period. This share has increased to approximately 41 % by the end of the period.

The share that these fires make out of all residential fires has shown an increasing tendency for the period of 1995-2009.

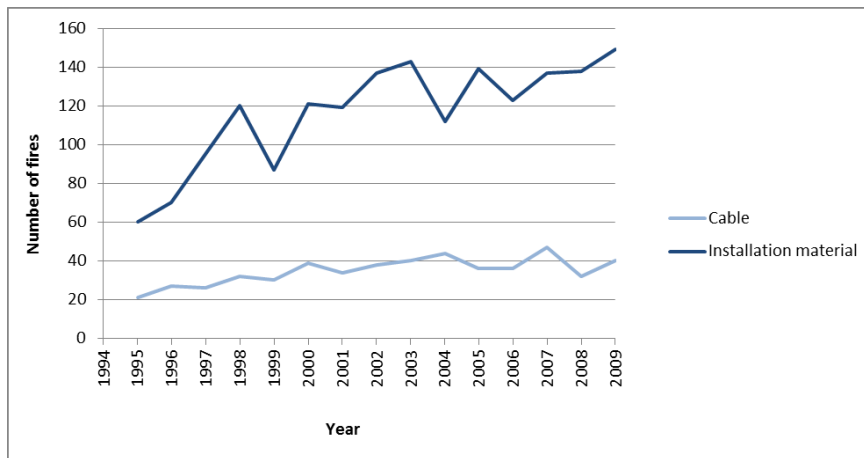

Figure 3-3 Development in number of residential fires starting in installation materials, wiring and cables, during a 15 year period of 1995-2009. *Wiring, cable* is included in *installation material* (the figure is based on data from the DSB fire statistics).

Figure 3-4 shows the development of fires caused by different installation materials. The figure shows that cables caused most fires in installation materials, and that the number of such fires has been increasing during the 15 year period, from about 20 to 40 fires annually. It must be pointed out that the statistics from DSB does not show whether the fire was caused by e.g. overheating in the termination point (socket outlets, termination boxes etc.), or overload of the cable. Furthermore the statistics is unable to tell whether a breakdown of a cable is due to ageing or if the cable is destroyed mechanically, e.g. penetrated by a nail. In addition there is made no distinction between fire in an installation cable or in a cord extension in the DSB fire statistics. It is shown in the figure that socket outlet materials cause the second most fires, between 20 to 40 fires per year.

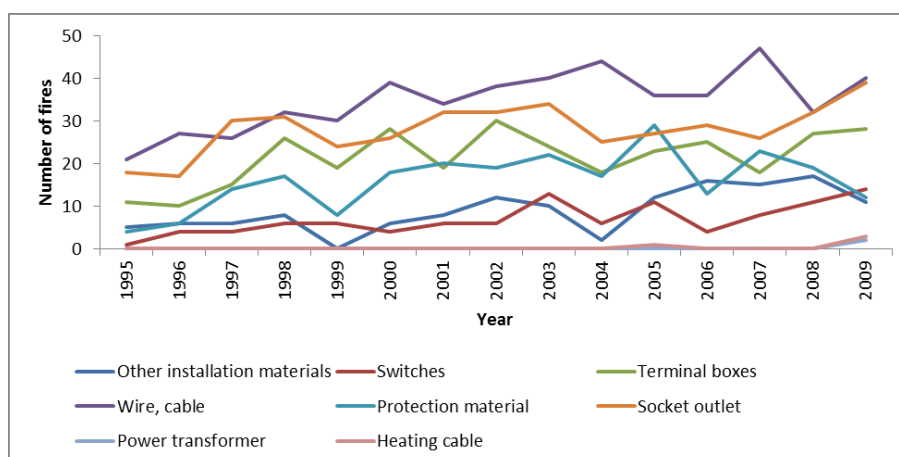

Figure 3-4 Distribution of the number of residential fires according to the type of installation materials causing the fire, in the period 1995-2009 (the figure is based on data from the DSB fire statistics).

The share of fires with origin in cables and in other types of installation material amounted to respectively 1 and 2 % of all residential fires in 1995. The share of residential fires starting in installation materials showed an increasing tendency towards approximately 4.5 % in 2009. The share of fires starting in cables also shows an increasing tendency, but it seems that the increase has been considerably lower than that for installation materials in the period 1995-2009, and the share of residential fires starting in cables in 2009 was well below 2 % of all residential fires.

The distribution of fire causes for cables for the period 1995-2009 is quite similar to the distribution of the same fire causes for other types of installation materials. Almost half of the fires in both cables and other installation materials were caused by serial arcs, while 7.2 % of the fires in cables were caused by earth faults and 2.3 % by leakage current.

More than 40 % of the fire causes with electrical origin are categorized as "Other electrical cause". The fires in this group had electrical causes that are not covered by the four categories in the fire cause statistics of DSB. Based on a study of the comments field in the fire cause statistics form, it may seem as these fires are primarily caused by *overheating* and *short-circuiting*.

3.3 Fire statistics in Sweden

Sweden has been collecting detailed statistics on fires in buildings since 1998. The statistics are either based on reports from the fire officers responsible for fire brigade operations, or on more detailed reports that are prepared after fires with casualties. Information that may be registered is cause of fire, type of object where the fire started, estimates of fire spread and casualties.

There is no specific field where cable fires are registered in the reports. However, "other electric installations" are mentioned. There is, however, no data if cables are involved in either fires starting in electric installations, or in other starting objects. Electrical causes are not listed as a fire cause. However, for objects where the fire started, electric installations are listed. It is not clear if cables may be included in this group, and no clear conclusions can be made based on this data.

The data on fires with electrical cause is presented below. Table 3-1 shows data for 1328 fires involving one or more casualties in the period 1999 to 2011. These data contains more than just fires in buildings, but other objects constitute less than 10-15 % of all the fires.

Table 3-1 Data on starting objects for fires in Sweden with at least one casualty in the period 1999-2011

| Object where the fire started | Number of fires | % of total |
|---|------------------------|-------------------|
| Other electric installations | 18 | 1 % |
| Distribution board | 3 | 0 % |
| Other | 102 | 8 % |
| Unknown | 400 | 30 % |
| Other known objects (i.e. beds, clothes, stove, sofa etc) | 805 | 61 % |
| Total | 1328 | 100 % |

Table 3-2 shows data from all building fires where the fire brigade operated, a number of 150 979 fires in the period 1998-2011.

Table 3-2 Data for Swedish building fires where the fire brigade operated in the period 1998-2011.

| Object where the fire started | Number of fires | % of total |
|--------------------------------------|------------------------|-------------------|
| Other electric installations | 5224 | 3 % |
| Distribution board | 1082 | 1 % |
| Other | 32028 | 21 % |
| Unknown | 17667 | 12 % |
| Other known objects | 94978 | 63 % |
| Total | 150979 | 100 % |

Note that the share of fires with unknown cause is 30 % in the fires with at least one casualty, and 12 % in all building fires where the fire brigade operated. This difference may have many explanations, but one cause may be the difference in number of fires in the two tables. Another reason may be that declaring a fire cause with a high level of certainty may lead to a judicial inquiry, and is therefore avoided.

3.4 Finnish data

In a Finnish paper from 2002, cable fires were attributed to 48 of 1566 fires with large economic losses in the period of 1980-2000 [30]. This corresponds to 3 % of the total numbers of fires in Finland. It was concluded that the fires related to cables are less costly, but still causing significant losses.

3.5 Summary of statistical data

About 20 % of building fires in Norway is found to be caused by electrical faults in electric installations or electrical appliances [31]. Between 1 and 2 % of residential fires are found to start in electric cables. A rough estimate is that 2 % of all fires in Denmark start in electric cables. There is no specific data from Sweden on how many fires that start in cables, but according to the information given in Table 3-1 and Table 3-2 it is assumed that the share of all building fires is below 3 %. The data presented in the Finnish paper from 2002 also supports this frequency level. However, there is no information on why the fires started, or if the cables were in a permanent installation or loose extension cables.

There is no available statistics that give information on how cables may have contributed to fire development in building fires.

3.6 Reported fires with cables involved

The SINTEF-report on fire properties of electric cables from 2012 gave an overview over cable fires reported in different media sources [19]. Many of the articles found in online papers were about small fires, and were written shortly after the incident, and therefore not reliable with respect to a certain fire cause.

There were also several examples on fires in cables in metro tunnels. These fires did normally not lead to personal injuries, but to train stop and large consequences for the train traffic.

Some of the fires with larger consequences have been investigated more thoroughly, and are briefly described below.

3.6.1 Cable fire in Oslo Central Station, Norway, 2007

In November 2007 a fire started when a high voltage cable was damaged during maintenance work at Oslo Central Station. The fire was investigated by DSB [32]. The fire led to full stop in the railway traffic for one day, and 80 000 commuters were affected. The smoke spread through the ventilation system, and the whole station area was evacuated. However, the cable fire also cut off the police's data system and the internet connection for a large number of users [33, 34].

3.6.2 Fire in a nursing home in Harstad, Norway, 2001

This fire was evaluated by the Norwegian Building Authority (DiBK) and the Norwegian Directorate for Civil Protection (DSB) [35]. The nursing home Bergseng bo- og servicesenter in Harstad has 3 floors, and contains a department for 9 dement patients and 28 flats for elderly people with care needs. The fire started in the kitchen, and a box of EPS and packaging for hot food were involved in the early phase of the fire. The door to the kitchen was open, and the corridor was quickly filled with smoke. The fire brigades were alarmed and extinguished the fire efficiently from the outside of the building. 3 patients died in the fire. A limited part of the building had considerable soot- and smoke damages, while the damage to the rest of the building was small or negligible.

A problem during the extinguishing was that cable ladders of a polymer material were mounted unprotected on each side of the ceiling in the corridor. Due to the heat, the trays melted, and cables fell down and hindered the fire brigade's movement in the corridor, and seeking for persons was difficult. After the fire melted material from the cable trays, cable insulation and some from lighting fixtures was found. There were observed some melted insulation on the cables, but less direct fire damage.

3.6.3 Fire in Frogner telephone central, Oslo, Norway, 1986

A fire in Frogner telephone central in Oslo in October 1986 led to large damages, and 25 000 subscribers lost their telephone connection [36]. The most plausible fire cause was overheating of components, and the fire started in the first floor. The smoke spread to the 2. floor through leakages in cable penetrations. The building was not sprinkled. The losses of the telecommunications company were estimated to 100-150 million NOK in that time's value. The losses for companies in the area were also anticipated to be high, since they were without telephone connection for a long period of time.

3.6.4 Fire in Rockefeller Center, New York, USA, 1996

A larger fire in Rockefeller Center in New York in 1996 was found to have an electrical cause [37]. The room of origin was an electrical central on the 5th floor. Cables in the room were ignited and produced large

amounts of smoke. The fire spread to 4 other electrical rooms and the smoke development was very large. The fire was deep seated in the cable system over several floors, and therefore difficult to extinguish. It took about 300 fire men 4 hours to extinguish the fire. 5 civilians and 12 fire men were injured in the fire. The cables were mounted on open cable trays, and over the years more cables had been added to the cable system. The investigators assume that the insulation of cables at a point was burnt off, and that large amounts of electric current passed through the bundle of cables.

3.6.5 Fire in an ilmenite smelting plant in Tyssedal, Norway, 1988

By tapping off slag in the ilmenite smelting plant in Tyssedal, the cable insulation of a cable line was ignited by radiation heat exposure. The cables were mounted vertically, and the insulation was not protected in any way. The fire produced large amounts of smoke and spread along the cable line, despite fire classified cable penetrations. The losses were estimated to 50-100 million NOK in that days value. 171 workers were obliged to take a temporary lay-off for 3 months [38].

3.6.6 Fire in a paper mill in Obbola, Sweden, 2007

A fire started in the paper mil SCA Packaging in Obbola in Sweden in January 2007 [39]. The fire started in cables and cable ladders between two buildings. The fire could therefore be confined, and no persons were directly affected. 7 cable ladders were completely destroyed in the fire, and led to power failure and production standstill.

3.6.7 Summary of reported fires in cables

The fires referred to here have in common that they involved cables. The incidents, except the fire in the Harstad nursing home, do also have in common that the fires led to large damage as a consequence of the fire, i.e. loss of electric power, loss of data- and telephone communication that affected important activities. Considerable smoke production is also a common factor in these fires. For the Harstad nursing home fire, an important factor was the mounting of the cables on cable ladders that melted. It has not been found information on which type of cables were involved in the fires, if the cables were fire rated etc.

4 Regulation of fire properties of cables in the EU

4.1 The Construction Products Directive

The European Construction Products Directive (CPD) was published in 1989, and its purpose is to remove technical barriers for construction products between the member countries [40]. 6 basic requirements are defined, where fire safety is one of them. This requirement also applies for all cables and wiring systems that are permanently installed in a building, both electric cables and communication cables with conductors of metal or optical fibres. National building regulations may specify different reaction-to-fire properties, depending on the type of building and its area of application. In such circumstances it must be documented that the product satisfies the requirements, and compliance with specific test standards is one way of documenting reaction-to-fire properties.

On 1st of July 2013 the Construction Products Directive will be replaced by the Construction Products Regulations (CPR). CPR will be more binding, and its purpose is to secure a more harmonised set of rules in all the EU countries. The regulations will entail a stricter market surveillance concerning construction products.

The European classification system for resistance-to-fire properties and for reaction-to-fire properties was published in 2000 [41, 42], whereas the system for classification of the reaction-to-fire properties of cables was published in 2006 [43]. The entry into force of these decisions in the member states is mandatory, and the authorities must implement the system in the national building regulations as well as state what classes are acceptable for which applications. In addition, the necessary harmonised standards must be in place, i.e. published on the mandate from the Commission, and published in the European Official Journal. This is required for both product standards as well as for standards for testing and classification. Finally, the authorities are required to notify conformity of assessment bodies who may certify the products. As members of the European Economic Area (EEA), all the Nordic countries are obliged to comply with these decisions.

For the time being, the system is not completely in place. It will still take some time before the system can be implemented so that cables can be CE-marked using fire classes as specified by the Construction Products Directive. However, it will be possible to implement the classes in national building regulations before the system is in place. CENELEC was mandated by the EU Commission in May 2009 to develop a harmonised product standard (hEN) in order to be able to CE-mark cables according to the Construction Products Directive. Development of test standards was also included in the mandate. The product standard EN 50575 for cables is titled *Power, control and communication cables – Cables for general applications in construction works subject to fire requirements* [44].

The EU Commission has agreed that all cables in the highest reaction-to-fire classes (A_{ca} , $B1_{ca}$, $B2_{ca}$, C_{ca}) should comply with system 1+ under the system for attestation of conformity [45, 46]. This means initial type-testing, factory production control, audits and audit-testing of samples. Products classified as D_{ca} and E_{ca} , follow system 3, which implies initial type-testing and factory production control.

4.2 The Low Voltage Directive

The European Low Voltage Directive (LVD) was initially published in 1973, and the newest version of LVD in 2006 [47]. Both cables and enclosures are governed by this directive [48].

LVD presents three main elements with regards to safety requirements on electrical equipment:

1. General requirements.
2. Protection against hazards arising in the electrical equipment (including radiation and formation of electric arcs).
3. Protection against hazards arising during external influence upon the electrical equipment.

Item (b) under the security requirements under the article 3 above, states that technical measures shall secure that the electrical equipment is resistant to non-mechanical influences in the expected environmental conditions it is meant to function in, so that persons, domestic animals and property is not endangered. We interpret this to include exposure to fire.

There is a vast amount of standards within the field of electrical safety. Some are published by the international organisations ISO and IEC, others by the European CENELEC, and some are national standards developed and published by the national standardisation organisations. There may be links and similarities between some of these categories of standards, and some of the standards with different designations may be identical. This makes the area somewhat complicated to non-experts. For requirements to fire properties of cables, many different standards are mentioned in the national regulations in the Nordic countries. In the table below we try to give an overview over these standards, the link between them and in which country's regulation they are mentioned.

4.3 The system of euroclasses for cables

The level of the different euroclasses for cables can be interpreted follows [14, 49, 50].

Class A_{ca}

Practically non-combustible products, i.e. ceramic products.

Class B1_{ca}

Products that are combustible but show no or very little burning when exposed to both the reference scenario tests and the classification test procedures given in EN 50399.

Class B2_{ca} and Class C_{ca}

Products that do not lead to a continuous flame spread when exposed to the 40-100 kW ignition source in the horizontal reference scenario. These products show a limited fire growth rate and a limited heat release rate when tested according to EN 50399 with a 30 kW burner and backing board.

Class D_{ca}

Products that show a fire performance better than ordinary not flame retardant treated polyethylene and a performance approximately like wood when tested in the reference scenarios. When tested according to EN 50399 with a 20.5 kW burner and no backing board, these products show a continuous flame spread, a moderate fire growth rate, and a moderate heat release rate.

Class E_{ca}

Products where exposure to a small flame does not cause a rapid flame spread.

Class F_{ca}

No performance determined.

Additional classes for smoke, burning droplets and acidity of the smoke are designated as follows:

- Smoke:
 - o s1, s2, s3 (tested according to EN 50399)
 - o s1a, s1b (tested according to EN 61034-2)
- Flaming droplets or particles:
 - o d0, d1, d2 (tested according to EN 50399)
- Acidity:
 - a1, a2, a3 (tested according to EN 50267-2-3)

No interpretation of the additional classes is given in the classification standard, but the classes are ranked with the lowest number designating the best performance (i.e. s1 is better than s2 and s3, d0 is better than d1 and d2 etc). However, the smoke classes s1a and s1b reflect requirements that have been in use for a long time in Europe. The acidity-classes do also have a background in long traditions.

The 7 euroclasses and the 11 additional classes can be combined into 183 different combinations. The classes A_{ca}, E_{ca} and F_{ca} are not combined with any additional classification.

5 Which fire classes do cables in the Nordic countries satisfy today?

5.1 European cables in the CEMAC-project

113 cables representative for the European market were tested in the CEMAC-project [2]. The distribution in heat and smoke classes are shown in Figure 5-1 and Figure 5-2 below. These figures should not be seen as a measure of the frequency of different classes in production but rather as an indication of availability of all classes.

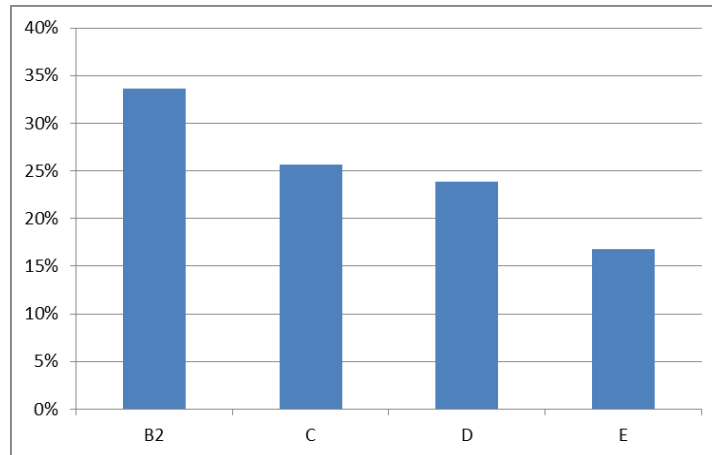

Figure 5-1 Distribution of heat classes of the cables in the CEMAC-project.

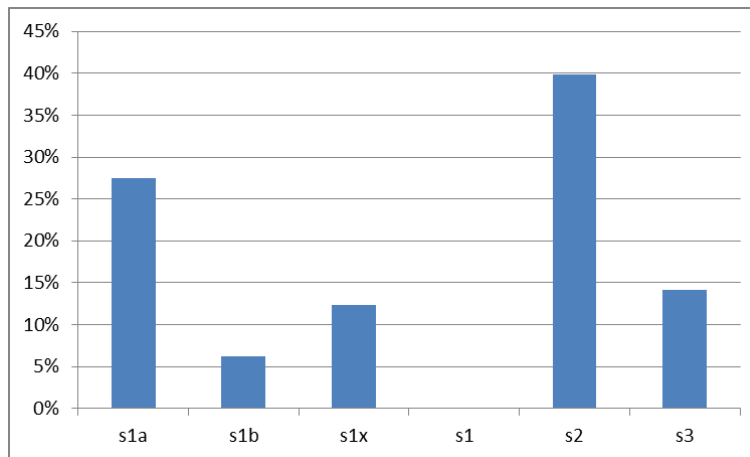

Figure 5-2 Distribution of smoke classes for the cables in the CEMAC-project. S1x means that the cable fulfills the requirement of s1 but it has not been investigated if it also complies with the requirements for s1a or s1b.

5.2 Cables in Denmark

Through a meeting between DBI and the Danish cable manufacturer NKT Cables in May 2013, the cable industry informed that it should be expected that they will be able to satisfy the requirements to all cable classes from B and lower [51]. It will, however, be difficult to satisfy the criteria to no flaming droplets (subclass d0). Producing cables with better fire performance will require higher costs. It is anticipated that the major part of all Danish cables today satisfy class E_{ca} . A minor part of the cables are delivered as class B2 to special project (e.g. for tunnels and power plants). There is no documentation available to validate this information.

5.3 Cables in Norway

According to information from Norwegian cable manufacturers, cables with PVC insulation will satisfy the requirements for class E_{ca} . Cables without halogens in the insulation will satisfy class D_{ca} . A table presented as a basis of discussion by the Norwegian cable industry at a CPR project meeting in "Europacable-Norway", is reproduced in Appendix A [52]. Of the 10 tested halogen free cable families in this table, only one achieves smoke class s1, whereas 9 satisfy the requirement for s2. All these cables produce burning droplets as class d2, and the acidity of the smoke is class a2. The table also includes examples of data transmission cables and alarm cables.

5.4 Cables in Sweden

According to Swedish cable industry [53] more or less all halogen free cables comply with the requirements for class E_{ca} . The majority of cables would also comply with D_{ca} with or without minor modifications and relatively small increases in costs. The construction of B_{ca} cables is much less straightforward, especially for small conductor cross sections. As a rough indication the costs would increase by at least 10-15 % if D_{ca}/E_{ca} cables should be redesigned to B_{ca} rating.

Falling droplets is a much more important concern for cables than it is for e.g. gypsum board. It is feasible to construct d0 cables, but this is achieved by designing the cables for an "reinforced" B_{ca} , with the added costs that follow. C_{ca} is a relatively narrow class, and few cables fall into this.

The cost indications are very preliminary and depend to a large extent on the conductor cross-section. It should be noted that the higher costs for B_{ca} cable lie not only in increased design costs but additional cost is also imposed due to the 1+ control system.

6 Regulation of reaction to fire properties of cables

6.1 Regulations in Denmark

6.1.1 Building regulations in Denmark

In the Danish Building Regulations 2010 (BR10), clause 5.5.1(1) it is stated that internal surfaces shall not contribute significantly to fire or to smoke emission during the period of time needed to allow people occupying the room to reach a safe area [54].

Collated examples of fire safety measures in buildings 2012 (EBB) do not contain further guidance for electric cables, even though it is stated in the guidance text to Building Regulations 2010, clause 5.5.1(1) that internal surfaces comprise wall and ceiling finishes and flooring [55]. This provision also covers suspended ceilings, sound-absorbing products, decorations, notice boards, electric cables, pipe insulation and similar surfaces in significant quantities.

The Collated examples of fire safety measures in buildings 2012 (EBB), clause 6.2.2 prescribes that “fire safe” cables should be used in rooms where mechanical smoke venting systems are used.

In the current Danish building regulations with guidelines there is no specific reaction to fire requirements for electric cables referring to standards. However, reaction to fire requirements may still be a part of project prescriptions for fire safety installations. In general “fire safe” cables according to IEC 60331 should be used for fire installations like automatic fire alarm systems, warning systems, fire ventilation systems etc. This is not described in the EBB, but in the respective design guidelines.

6.1.2 Regulations of electric installations in Denmark

Denmark follows in general the directive for high power installations with national additions written below [56]:

- Cables fulfilling EN 50265-1¹ and EN 50265-2-1² and other products (cable conduits etc.) that fulfil EN 50085³ and EN 50086⁴ can be installed without any restrictions.
Note 1: Cables in high-risk spaces can be required to fulfil stricter demands of bunched cables according to HD 405.3.
Note 2: The Danish Standard DS 2393-series are considered to be covered by the standards EN 50265-1 and EN 50265-2-1.
- Cables not fulfilling the requirements to flame spread according to EN 50265-1 and EN 50265-2-1 can still be installed but only in short lengths for connection of equipment, and they may under no circumstances penetrate a fire cell partition.

For installations in exhibitions, concert halls and similar areas where no fire alarm system is installed the following requirements apply:

- Either fire restricted according to (IEC 60332-1) HD 405-12 or HD 405-34 (IEC 60332-3) and with low smoke production according to IEC 61034⁵.

¹ Superseded by IEC 60332-1-1 and IEC 60332-2-1

² Superseded by IEC 60332-1-2

³ EN 50085 Cable trunking systems and cable ducting systems for electrical installations (3 parts)

⁴ EN 50086, Conduit systems for electrical installations (5 parts)

⁵ IEC 61034:2006: Measurements of smoke density of cables burning under defined conditions, Part 1 and 2

- Or all unarmoured cables or wires shall be inside metallic or plastic pipes/conduits that give a fire protection according to IEC 60614⁶ or IEC 61084⁷ and has an enclosure class of at least IP4X.

For temporary electric installations at construction sites, amusement parks, markets, circuses etc. the following apply:

- All electric cables shall comply with EN 50265-1 and EN 50265-2 (IEC 60332-1).
- In areas with high risk for fire spread the cables should comply with IEC 60332-3.
- Where there is need for low smoke production materials cables shall have smoke production properties as a minimum fulfilling IEC 61034.

For emergency lighting and warning systems, where required by the Danish Building Regulations, only the following wiring systems can be used:

- “Fire safe” cables according to IEC 60331.
- Mineral insulated cables.
- Heat resistant silicon rubber insulated mounting wiring type H05Sj-K in pipes.
Metal pipes shall be used in hidden installations in combustible building elements and everywhere in visible installations.
- Other suitable wires or cables by special permission from Elektricitetsrådet (the Danish Electrical Council)⁸.

These regulations have not been updated since 2001.

Signal and data cables

According to available information, there are no reaction-to-fire requirements to signal cables and data cables in Denmark.

6.2 Regulations in Finland

6.2.1 Building regulations in Finland

The Finnish building regulations do not mention electric installations specifically. From paragraph 4 *Prevention of ignition, 4.1 General requirements* of the Ministry of Environment’s regulation on fire safety of buildings, E1 [57]:

4.1.1 The building shall be planned, built and designed so that the danger of the occurrence of fire is as small as possible. Occurrence of fire on the exterior of the building should also be considered.

4.1.2 Technical installations shall be designed so that the danger of the occurrence of fire and the spread of fire and smoke is not significantly increased as a result of them.

Paragraph 8, *Limitation of fire development, 8.1 General requirements*:

8.1.1 Constructions products used in buildings shall not contribute to a fire developing in a way that may lead to danger.

⁶ IEC 60614, Specification for conduits for electrical installations (7 parts)

⁷ IEC 61084, Cable trunking and ducting systems for electrical installations (4 parts)

⁸ Sikkerhedsstyrelsen took over Elektricitetsrådet’s responsibilities in 2003.

6.2.2 Regulations of electric installations in Finland

The Finnish Safety and Chemicals Agency, Tukes (Säkerhetsteknikscentralen) supervises the safety of electric installations in Finland. A part of its responsibility is fire safety of electric installations.

According to the Trade and Industry Ministry's decision on the safety of electric installations 17.12.1999/1193, electric installations shall be designed, built and repaired in accordance with good engineering practice. Electric installations shall also satisfy safety requirements given in an appendix of the decision. The fulfillment of the essential safety requirements shall be documented by use of technical specifications determined by an official standardization body and shall be publically available. The electrical safety authority shall define a list of standards that corresponds to the essential safety requirements [58].

Included in the list of essential safety requirements are:

...

3. An electric installation shall be designed so that there may be no danger of a combustible material not part of the installation, being ignited as a consequence of high temperature or electric arc.
4. Electric installations must not lead to any of burn injuries for persons or pets.
7. The protection of the system shall function during the current, voltage and period of time that guarantees sufficient safety.
8. The electrical protection system of an electric installation shall be selected with consideration to functionality and reliability during the entire period of operating time of the electric installation.

The list of standards as defined by the electrical safety authorities (Tukes) and relevant for fire safety is Tukes instruction S10-2011 [59]. The following standards with relevance to fire safety are stated as corresponding to the essential safety requirements of [1193/1999] [59]:

- The standard series SFS 6000 (2007) *Low voltage installations*
 - *SFS 6000-4-42 Low voltage installations. Part 4-42: Protection methods. Protection against thermal influence.*
- SFS 6001 (2001) *High voltage installations*

SFS 6000-4-42 is based on the CENELEC HD⁹ 60364-4-42:2011 standard but has some deviations that are marked [60].

422.2.1 is marked as deviating from CENELEC HD 60364-4-42:2011. Here it is referred to section 10.5.5 of the building regulation E1, where it is stated that products, building components or equipment which will increase the fire load or, by their production, may put health and safety of people in danger, are not allowed to be mounted in exits. Wiring without specific protection may be placed in exits only to feed necessary electrical equipment such as lighting fixtures and socket-outlets. Wiring necessary for other applications shall be protected or selected by satisfying any of the following:

- In wiring systems cables shall satisfy the requirements of the testing standards
 - EN 60332-3
 - EN 50267
 - EN 61034Examples of such cables will satisfy the standards SFS 5544 and SFS 5546.
- Separate channels or other spaces with sufficient number of service doors for maintenance access are used. The wiring systems are protected with a construction of minimum resistance-to-fire class

⁹ A Harmonization Document (HD) is a normative document made available by CENELEC in the three official languages. www.cenelec.eu/standardsdevelopment/ourproducts/harmonizeddocuments.html

EI 30. The construction is to be built using a non-combustible or limited combustible material (class A2-s1,d0).

- Another method is applied, with an advocated statement from a neutral research institute.

In annotation 1 the exit is defined as a door leading out to safety or a space within the building or outside of it, through which a safe evacuation to the ground or another safe spot is possible in the event of a fire. In this context the exit is often a staircase.

Annotation 2 informs that there is a harmonization process under development in Europe for the regulations on building and testing of the fire properties of cables and that fire classification of cables are being developed.

422.2 In exists it is only allowed to install distribution boards serving safety in the exit, without separate protection. If there is still need for another distribution board in the exit it shall be separated from the space by a construction of at least resistance-to-fire class EI 30. Materials used for building the construction shall be non-combustible or limited combustible (A2-s1,d0).

Appendix 42X

In appendix 42X of SFS 6000-4-42 an informative directive about classification for spaces on the basis of danger of fire is given. With reference to the Finnish regulations on building fire safety it is referred to the following publications:

E1 Fire safety of buildings, regulation and instructions

E2 Fire safety of production and storage facilities, instructions

E7 Fire safety of ventilation systems, instructions

These publications have not defined requirements on electric installations in different spaces. This is therefore described in the appendix 42X.

6.3 Regulations in Iceland

6.3.1 Building regulations in Iceland

Generally, the reaction-to-fire properties of building materials shall be documented with reference to EN 13501-1. In Iceland there are some requirements on linear pipe insulation (also with reference to the classes in EN 13501-1). There are no requirements specifically for the fire properties of cables [61].

6.3.2 Regulations of electric installations in Iceland

Regulations for electric installations are placed under the responsibility of the Iceland Construction Authority. The standard IST 200:2006, Electric Installations in Buildings (IEC 60364/CLC HD60364, corresponding to the Swedish standard Elinstallationsreglerna SS 436 40 00) applies. Generally, rule 422.2 applies, categorizing buildings into BD2, BD3, BD4, as well as rule 422.1 requiring that cables, under certain conditions, shall not contribute to spread of flame or fire growth [61].

Generally, it is very likely that Iceland will follow any requirements on the reaction-to-fire properties of cables agreed upon by the other Nordic countries.

6.4 Regulations in Norway

6.4.1 Building regulations in Norway

The Norwegian building regulations (TEK10) were published as a new version on 1 July 2010 [62]. This is a performance-based regulation without detailed requirements on specific products. The guidance to the regulations, VTEK10, states the necessary minimum performance in order to fulfill the requirements of the regulations [63].

The performances are given with respect to possible consequences a fire may lead to in different types of buildings, and are based on a system of fire classes and hazard classes as defined in TEK10. The hazard classes shall provide a basis for design and construction to ensure escape and rescue in case of fire, while the fire classes are based on the consequence a fire may imply for life and health, society and to the environment shall ensure the structure's load bearing capacity in case of fire.

Cables are, as most other construction products, not mentioned specifically in the regulations, but the requirements in § 11-9 and § 11-10 as translated and cited below, would be applicable also for cables (electric as well as signal- and data cables), wires and enclosures in electric installations in buildings. The text is referred from the English translation of TEK10 on the web [64]

§11-9 *Reaction-to-fire properties of products and materials*

(1) Structures shall be designed and constructed to ensure the probability of fires occurring, developing and spreading is minimal. The use of the structures and time necessary for escape and rescue shall be taken into account.

(2) Products and materials shall not have characteristics that make an unacceptable contribution to the development of a fire. Weight shall be given to the possibility of ignition, speed of heat transfer, smoke production, development of burning drops and time to flashover.

§11-10 *Technical installations*

(1) Technical installations shall be designed and installed to ensure an installation does not substantially increase the risk of a fire occurring or a fire and smoke spreading.

(2) Installations intended to perform a function during a fire shall be designed and constructed to ensure their function is maintained for the necessary time. This also includes the necessary supply of water, electricity or signals that are needed to maintain the installation's function.

The guidance to the building regulations specifies the performances required by different construction products in order to meet the requirements in TEK10, e.g. by stating the required fire classifications in order to achieve an acceptable fire safety level. Fire classes for cables are not yet implemented in the current guidance. However, it is required that cavities above suspended ceiling in escape routes space shall be defined as an individual fire cell if it contains cables representing a total energy of more than 50 MJ per running meter of cavity/corridor.

The guidance to the first section of TEK 10 §11-10 *Technical installations* states the following:

Pre-approved performances – electric installations

Cables can contribute to flame spread and considerable smoke production. The following performances are therefore required:

1. *Cables must not be placed above a suspended ceiling or in other cavities in escape routes, unless*
 - a. *the cables represent a low total energy (less than appr. 50 MJ/running meter of cavity, or*
 - b. *the cables are installed in a separate shaft with shaft walls with a fire resistance performance corresponding to the fire separating elements or*
 - c. *the ceiling is of a fire resistance equivalent to the fire separating element, or*
 - d. *the cavity is provided with a sprinkler system*

Cables of low total energy (less than 50 MJ/ running meter corridor/cavity) can be installed in escape routes. This is a specific exception for cables. It cannot be used as grounds for other derogations from pre-approved performances.

6.4.2 Regulations for electric installations in Norway

The regulations for electric low-voltage installations (FEL) declare several requirements connected to fire safety for cables [65]. §22 declare requirements for the protection against high temperatures:

§ 22 Protection against harmful thermal effects

Electric installations shall be finished in such a way that there is no danger of ignition of combustible materials due to elevated temperatures or electric arcs. It shall, during normal operation, not be any danger for persons or domestic animals to be exposed to fire.

Appendix 1 in FEL declares national adaptations in the regulations. One of these adaptations concerns wiring in escape routes.

Wiring in escape routes

This section defines conditions associated with the interface towards the rules about technical installations in escape routes as stated in the Planning and Building Act (with accompanying regulations and guidance documents).

Wiring shall preferably not be installed in escape routes. If such installation cannot be avoided, the wiring shall be equipped with a sheath or an enclosure that will not contribute to or spread a fire or reach such temperatures as to ignite adjacent materials during a period of time that is established for escape routes.

Cables shall not be placed behind a ceiling or similar cavities in escape routes unless

- *the cables represent a small fire load.*
- *the cables are installed in a separate shaft with walls having a fire resistance corresponding to that of the fire separating element.*
- *the ceiling is of the same fire resistance as the corresponding fire separating element.*
- *the cavity is equipped with a sprinkler system.*

Wiring systems installed in escape routes shall be out of reach or be equipped with protection against any mechanical damage during and escape. Every wiring system in an escape route shall be as short as possible.

Generally it is recommended that cables are used that do not produce harmful amounts of toxic gasses during a fire.

Coverings or enclosures with combustible material coated with fire-protective paint do not fulfil the requirements in this regulation.

NEK 400 is a Norwegian electro technical norm concerning electric low-voltage installations developed by the Norwegian Electrotechnical Committee (NEK), and is a collection of 41 individual standards [66]. NEK 400 is based on the norm IEC/CENELEC 60364. All the standards of NEK 400 are based on corresponding standards from CENELEC or IEC, except in part 8, which are national norms. NEK 400 is accepted as a description of methods intended to satisfy the safety requirements as stated in regulations on electric low-voltage equipment (FEL)[65]. Provisions with relevance for fire properties of cables, wiring systems and enclosures are mainly gathered in NEK 400-4 and NEK 400-5.

NEK 400-4-42. Protection against thermal effects, NEK 400 Section 421.3

A material that is safe in the event of an electric arc is described as a material that

- is non-combustible
- has low thermal conductivity
- is of sufficient thickness in order to secure mechanical stability

Fiberglass with a thickness of 20 mm is mentioned as an example of a material that is safe with respect to electric arcs.

Enclosures used as protection of equipment shall be made of a material that can resist the highest temperature that the electrical equipment may cause.

Combustible materials can be used as enclosures if they are covered by non-combustible material or a material that is difficult to ignite and that has low thermal conductivity.

Chapter 422 has the title *Protection against fire where there is a particular risk*

According to NEK 400, areas are divided into categories with respect to people density and evacuation conditions:

- BD2: low people density and difficult to escape
- BD3: high people density and easy to escape
- BD4: high people density and difficult to escape

422.2.1 treats wiring systems in escape routes:

Wiring systems in escape routes shall be as short as possible. Wiring systems shall not be able to spread flames.

In annotation 1 to this it is stated that the following products will satisfy this requirement:

- Cables: fire testing according to NEK EN 60332-1-2
- Conduits: conformity to NEK EN 61386-1
- Cable channel systems: conformity to NEK IEC 61084-1
- Cable tray and cable ladder systems: conformity to NEK EN 61537
- Conductor rail systems conformity to the NEK EN 61534-series

Annotation 2 states the following:

For classification of cables the requirements of the Construction products directive shall be considered.

Under the conditions of BD2, BD3 and BD4, wiring systems that supply emergency circuits shall, where it is relevant, achieve fire resistance properties according to NEK EN 50200 with reference to the requirements of the Construction products directive.

Wiring systems in escape routes shall cause limited smoke production.

Annotation 4 to the item above states that this may be satisfied by a light transmission of minimum 60 % at test according to NEK EN 61034-2.

422.2.2 requires that electric installations placed in corridors under the conditions BD2, BD3 and BD4 shall be placed in enclosures or boxes made of a non-combustible material or materials that are not easily combustible.

422.3.4 states a number of fire-related requirements on cables and wiring systems:

- Cables shall pass a fire test specified in the NEK EN 60332-series.
- Cable channel systems shall pass a spread-of-flame test specified in the NEK IEC 61084-series.
- Conduits shall pass a spread-of-flame test specified in the NEK IEC 61386-series.
- Conductor rail systems shall pass a spread-of-flame test specified in the NEK IEC 61534-series.
- Cable tray and cable ladder systems shall pass a spread-of-flame test specified in the NEK IEC 61537-series.

In annotation 1 to this item it is stated that where there is a considerable danger for spread of flames, e.g. in long, vertical cable management systems or bundled cables, the cables should satisfy the flame-spread characteristics described in the NEK EN 60332-3 series. Annotation 2 states that flame-spread tests are always performed in vertical position.

422.5 requires special measures in building constructions that contribute to spread of flames. In the annotation it is stated that installation boxes and enclosures in accordance with NEK EN 6070-1 for walls with cavities and cables in accordance with NEK EN 60332-3 may be used.

422.6 concerns selection and fitting of electric installations in areas containing items of irreplaceable value. In annotation 2 it is stated that the following measures should be considered: installation of cables with improved fire resistant properties in case of fire, in accordance with NEK IEC 60331-1 or NEK IEC 60331-21 or equivalent.

6.5 Regulations in Sweden

6.5.1 Building regulations in Sweden

Regulatory requirements in Sweden as of 1st of March 2013:

The building regulations do not regulate cables directly, however, there is a general requirement for reaction to fire that is legally applicable to all construction products that are part of the building. The requirement states that all construction products that are visible or unprotected must fulfill the requirement of D-s2,d0. The requirements are higher in several environments, i.e. escape routes, assembly halls, etc. may require class B or C. There is a general exception for smaller construction parts and parts of the surface area, as of 20 %. When the exception is applicable the minimum requirement is D-s2,d0.

For certain products, such as pipe insulation, the concept of parallelism is used in the building regulations. This means that if the normal requirement would be D, C or B, the corresponding pipe insulation class would be used. This also means that the risk classification that has been used when setting the regulations is also applied in a parallel sense for certain products. The advantage of this is that it is also easy to add new classification systems for new product types, but at the same time maintaining the risk classification given by the authorities. It should be noted here that it may also be possible to make exceptions of the ground rule of parallelism, i.e. for pipe insulation there is a connection between surface areas to require a higher pipe insulation class if the surface is large.

The minimum requirement for D-s2,d0 is valid also for cables in a legal sense, but in practice only the IEC-cable classes are used.

6.5.2 Regulations of electric installations in Sweden

In Sweden, there has been requirements for electric installations in regulations that later were moved to the standards. The current standard is SS 4364000 and this covers electric installations in buildings – rules for design and erection of electric installations. The classification is as follows:

F2: SS-EN 50265-X

F4: SS-EN 50266-X

F2 refers to products tested and classified as a single insulated vertically mounted wire or cable, while F4 refers to products tested as vertically bunched wires or cables.

The general requirement for cables and electric materiel is class F2. For situations where installations are subject to certain risks, such as vertical shafts or when a larger number of cables are gathered, a higher class should be used. If the general requirement of F2 is not fulfilled, the cable may only be used for a very short distance and not passing a fire compartmentation.

Special requirements are set for high risk environments. Occupancies are classified into four categories, where the normal category is classified as BD1. For higher risk occupancies, BD2-BD4, there are special requirements, going higher than the general. BD2-BD4 contains occupancies such as tall buildings, assembly halls and public buildings. For escape routes in BD2-BD4 cables should not be installed, otherwise the cables must fulfill higher classes.

For occupancies where there is a larger fire risk due to stored materials or the preparation or manufacturing of such materials, higher classes are also required. For vertical shafts or larger number of cables, there are requirements for higher classes.

6.6 Similarities and differences between regulations in the Nordic countries

6.6.1 Building regulations

The Nordic countries have a long tradition on cooperation on development of building regulations for fire safety and development and use of fire test methods. That means that the building regulations in the Nordic countries to a large degree are based on the same considerations and philosophy regarding requirements to fire properties of construction products. A proposal of how fire requirements in the European system could be harmonised in the Nordic countries was presented in 2008, but the classification system for cables was not yet ready to be considered then [67]. None of the Nordic countries has implemented the new classes for cables in their building regulations yet.

6.6.2 Regulation of electric installations

The standards for electric installations are based on the same international norms from CENELEC and IEC. That means that the standards are similar to a high degree, with some national additions that are specific for each country.

Cables are selected based on national norms, and that means that there is a high degree of national differences concerning which types of cables that are applied. According to our knowledge, a large share of cables used in a country is produced specifically for the national market. As an example, approximately 90 % of the most common cables used in Norwegian installations (PR cables) are produced in Norway, and the situation is similar in the other Nordic countries [68]. That may imply that cables in the different Nordic countries may obtain different classifications in the new system of euroclasses, and that the present fire safety level may differ between the countries.

7 How may reaction to fire properties of cables be regulated?

7.1 General principles

Implementation of the reaction to fire classes for cables in the Nordic building regulations should be based on the following principles:

- The requirements should be pragmatic and provide for an efficient application.
- The current reaction to fire requirements for different types of buildings and parts of buildings will serve as a good basis. The principle of parallelity with requirements to surface materials used when implementing the euroclasses for pipe insulation is an example of how this may be done.
- The fire safety regulations for cables should be performance-based, like for other types of building materials. The fire safety level for cables, expressed as euroclasses, should be stated in guidelines to the regulations.
- The reaction to fire regulation of cables should be based on the ratio of exposed cable surface to the surface area of the fire compartment; either total area of ceiling and walls (as for pipe insulation in Denmark), or the area of the adjacent wall or ceiling (as for pipe insulation in Norway and Sweden). For smaller exposed areas, the required reaction to fire class may then be set lower than the required classification following the principle of parallelity.

The principle for determining reaction to fire requirements for cables should as far as possible follow the same logic as the requirements set to other types of building materials. That means that the requirements in certain areas where the risk for life and health is high in case of fire (e.g. escape routes, institutions, hotels etc) will be higher than in areas with a lower risk level.

The European system of reaction to fire classes implies in principle that there is a parallelity between classes for different groups of building products, like linings, floorings, linear products (ducts and pipe insulation) and cables. If class B-s1,d0 is required on a wall, it would be logical that any linear product mounted on the same wall also should fulfill class B_L-s1,d0, floorings should fulfill B_n-s1, and that cables satisfy class B1_{ca}-s1,d0,a1. However, there may be good reasons to deviate from this principle. One example is floorings, where the highest requirement according to Norwegian regulations is class D_n-s1. This level is based on a comparison between the former national class for floorings (class G) and the new system of euroclasses. D_n-s1 was found to correspond with the old class G, which in turn was assessed to represent an acceptable fire safety level in Norwegian buildings.

We do not have the same experience to help us express the present safety level for electric cables in Nordic buildings with respect to reaction to fire properties. There is no translation from the present fire requirements for cables given in regulations for electric installations into the new euroclasses, because the test methods are differing both in what properties that are measured, and how they are measured.

7.2 Requirements to cables vs requirements to linear products

One way to handle fire requirements to cables may be to treat them in the same way as the requirements to linear products in the Nordic building regulations. Even if types and amount of materials and localisation of cables and linear products may differ, these product groups do also have some similarities. The products may cross through several fire cells and fire sections, they may be mounted in escape routes, they may be placed in hidden spaces and voids, and some products may contribute to a fast spread of flames and considerable amounts of smoke. The present requirements for linear products in the Nordic countries are given below.

Norway

In the guidelines to the Norwegian regulations there is given a limit when the surface of the linear products exceeds 20 % of the surface area of the adjacent wall or ceiling [63]. If the surface is larger than this, it shall either satisfy class A_{2L-s1,d0} or be of the same class as the adjacent surfaces. The required class is always the same for walls and ceiling in the same type of building fire cell. If the total exposed surface area of pipe installations is less than 20 % of the surface area of the adjacent wall or ceiling, the following classes are required:

- B_{L-s1,d0} in escape routes. Exceptions are insulation on a single pipe or duct with an outer diameter up to 200 mm, and pipe- and duct insulation in shafts or over suspended ceiling with fire resisting function, where the required class is C_{L-s3,d0}.
- C_{L-s3,d0} in buildings in hazard class 3, 5 and 6, and in building fire class 2 and 3.
- D_{L-s3,d0} for all other insulation on pipes and ducts in hazard class 1, 2 and 4, and in building class 1. Exceptions are insulation on pipes and ducts in shafts, voids or over suspended ceiling with fire resisting function, where the required class is C_{L-s3,d0}.

Denmark

The Danish guidelines recommend that pipe insulations should at least fulfill class E_{L-d2} [55]. However, if one or more pipes in the room has a diameter above 106 mm, or if the total surface area of all pipes in the room exceeds 5 % of the total area of all walls and the ceiling, it is recommended to ensure that the pipe insulation surfaces represent a higher level of reaction to fire properties.

Sweden

The Swedish guidelines for pipe insulation follows the same principle applied in the Norwegian guidelines, with a distinction in the regulations when the surface area of the linear products exceeds 20 % of the surface area of the adjacent wall or ceiling [69]. If the surface is larger than this, it shall either satisfy class A_{2L-s1,d0} or be of the same class as the adjacent surfaces. In the Swedish regulations, there may be different requirements to surfaces on walls and ceiling in a fire cell.

If the total exposed surface area of pipe installations is less than 20 % of the surface area of the adjacent wall or ceiling, the following classes are required:

- B_{L-s1,d0} where adjacent surfaces shall fulfill B-s1,d0
- C_{L-s3,d0} where adjacent surfaces shall fulfill C-s2,d0
- D_{L-s3,d0} where adjacent surfaces shall fulfill D-s2,d0

The smoke requirements for linear products classes C_L and D_L are set lower than the corresponding smoke requirements for surface products of class C and D for pragmatic reasons.

May reaction to fire criteria to cables correspond to criteria to linear products?

Denmark has chosen a slightly different approach when determining reaction to fire criteria to pipe insulation. The limiting exposed area of the pipe insulation is related to the total surface area of walls and ceiling, and a criterion regarding the maximum pipe diameter is also included. There may not be a very big practical difference in the two ways of assessing the exposed pipe insulation area. Assessment of exposed area of cable surface may follow the same philosophy as for pipe insulation. How large the ratio of exposed cable surface to exposed surface of walls and ceiling may be has to be discussed.

When assessing fire requirements to cables based on the size of the exposed area, attention should be paid to other products in the fire compartment where a lower level of euroclass than for the surface of walls and ceiling is accepted (e.g. pipe insulation with a surface area less than 20 % of the adjacent wall or ceiling).

This is important to avoid that solutions acceptable one by one sum up to a total solution with an unacceptable fire safety level.

7.3 Proposal of an exception rule for smaller surface areas of electric cables

Cables could be considered as a part of the percentage surface area exception rule. However, the exception rule may be limited for ceilings in certain occupancies where the reaction to fire requirement is high, like in evacuation routes. This should be assessed based on how large the exposed surface area of the cables is. In many cases, cables would fit the percentage surface area rule. How large the limiting percentage should be must be considered more thoroughly.

New definition of the exception rule

The general exception of a certain percentage of the exposed surface should be kept. However, the meaning of the percentage surface area should be defined in the following way: The base surface area is calculated based on the adjacent surface area of linings, for example the ceiling area, or the closest one of the four wall areas in a square room. All exceptions that are closer to the ceiling than 1 m should be related to the ceiling area. Exceptions to the wall should be related to the wall area only. The percentage-exception-area is calculated by summing up the total surface area for fitments and linings for which the exception is used.

Regulatory requirement for cables where the percentage-exception is not used

Surface areas that may be excepted from the general surface class requirement are calculated as defined above. The principle of parallelity should be used as far as possible, that is the performance of the cables should match the performance of the linings. Using this principle is possible since the design of the classification system for cables is similar to the classification systems for the linings. As an example, a wooden lining of euroclass D corresponds directly to “wooden” cables of euroclass D_{ca} . Wood is used as a general reference material in Nordic building regulations, materials with similar reaction to fire properties to wood is regarded as a material with acceptable fire safety level for use in areas with a moderate fire risk. Normal untreated wood is classified D-s2,d0 according to the classified without further testing (CWFT) decision [70]. Therefore cable class D_{ca} could be chosen as a general requirement.

However, since the criterion of no burning droplets (d0) possibly is difficult to achieve, a pragmatic solution would be to require a lower class of droplets, d2 according to available information. Thus, the following general requirement would be relevant:

- Minimum class D_{ca} -s2,d2 when the surrounding surface area requirement is D-s2,d0

Regarding burning droplets: cables with classification d2 should be mounted in a way that minimize the risk of fire spread through burning droplets, protection below the cables may be necessary in some applications.

Regulatory requirement for cables in escape routes

Class C_{ca} -s1,d1 is proposed for cable installations where the total surface area exceeds the general exception rule based on a percentage calculation. For areas smaller than the percentage limit, we propose classification D_{ca} -s2,d2.

Approximation of exposed cable surface area

Calculating the exact exposed cable surface area may be a bit complex. It should also be noted that cables should be seen as a small construction product compared to others. The basic rule of percentage-exception is

not based on an exact number determined by scientific principles. Therefore, it would be reasonable to simplify the approximation of the exposed cable surface area.

The proposal is as follows:

For cables that are exposed from all sides, the exposed area A_{exp} may be approximated as:

$$A_{\text{exp}}=D \cdot L \cdot 3 \quad (7-1)$$

where D is the outer cable diameter, L is the cable length, and 3 is a simplification of the number π .

For cables that are protected on one side, the exposed area may be approximated as:

$$A_{\text{exp}}=D \cdot L \cdot 1.5 \quad (7-2)$$

Examples on how the exposed surface area can be estimated for different cable installations are shown in Figure 7-1. More calculation examples are given in Appendix B.

Example A:

4 single cables on e.g. a cable ladder, cables exposed from all sides:



Estimated exposed surface area would be $A_{exp} = D \cdot L \cdot 3 \cdot 4$

Example B:

4 single cables mounted with spacing on a ceiling or on a wall, only exposed from one side:



Estimated exposed surface area would be $A_{exp} = D \cdot L \cdot 1.5 \cdot 4$

Example C:

A single layer of 4 cables mounted in contact with each other on a ceiling or on a wall, only exposed from one side:

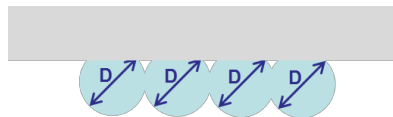

Estimated exposed surface area would be $A_{exp} = D \cdot L \cdot 1.5 \cdot 4$

i.e. for simplicity reasons, the calculation is the same whether there is space between cables or not.

Example D:

Multiple layers of cables mounted on a wall or on a ceiling, surface of n cables may be exposed to external fire:

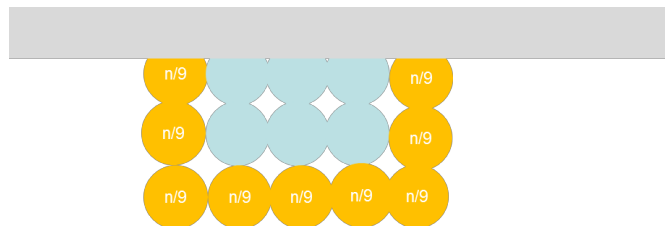

Estimated exposed surface area would be $A_{exp} = D \cdot L \cdot 1.5 \cdot n$

Figure 7-1 Four examples of how the exposed surface area of cable installations may be estimated.

7.3.1 Reaction to fire requirements in special spaces and when other products are involved

Other changes to the reaction to fire requirements may be relevant to improve and create consistency in the regulations:

- The percentage exceptions should be redefined for all surface areas, and include all exceptions related to linings and fixed furnishing. This would mean that the exception is calculated as a total for excepted cables, pipe insulations and other relevant products. This would be a more functional approach which would open for more cost-efficient designs without compromising the safety level. If not doing these changes, there may be a risk of having additive exceptions, i.e. x % cables + y % pipe insulation + z % other products – which could add up to a final unacceptable level of fire safety.
- The pipe insulation requirements are unclear and possibly higher than the normal requirements. While this may be relevant due to certain risks, it should be considered if the regulations could be adjusted to fit more logically into the reaction to fire requirement structure
- Requirements for reaction to fire should be clarified for concealed spaces, i.e. shafts and suspended ceilings. It is now unclear if surfaces in these spaces are considered to be exposed, and if the general – or no – requirements are applicable. This will be of specific importance for vertical shafts where a large number of insulation products, cables and other construction products may be present. A fire in a vertical shaft may spread quickly.

7.4 Proposal of classes to be used in the Nordic countries

All electric cables in buildings shall at least fulfill class E_{ca}.

For cables where the surface may be exposed to external fire, we propose that the additional requirements in Table 7-1 below apply.

Table 7-1 Proposal of classes for electric cables to be used in the Nordic countries

| Exposed area of cable surface | General requirement | One- and two story individual dwelling houses | Escape routes for all occupancies |
|-------------------------------|------------------------|---|-----------------------------------|
| > X* % | D _{ca} -s2,d2 | E _{ca} | C _{ca} -s1,d1** |
| < X* % | | | D _{ca} -s2,d2 |

* The percentage number X should be set in the range of 2-10 % and be calculated as the exposed area of cables in relation to the area of the ceiling. Some calculation examples are shown in Appendix B.

**This requirement applies only to the part of the exposed area that exceeds X%.

For spaces equipped with a fire alarm or an automatic fire suppression system, a cable class of one step lower than the required class may be used, i.e. E_{ca} instead of D_{ca}-s2,d2 or D_{ca}-s2,d2 instead of C_{ca}-s1,d1.

For the subclassification of smoke acidity, the proposal has no requirements – since there currently are no such requirements for other construction products. It should however be noted that for purchasers wishing to require cables that only produce acid free smoke there is the possibility of adding an a₁ or a₂ requirement. This may be the case in areas where protection of electronic equipment, data servers etc against corrosion by smoke is an essential requirement.

Certain spaces

Certain consideration should be given to fire spread in long vertical spaces, such as shaft and concealed spaces. If the general requirements and exception is valid for these spaces, then the wall requirements would be valid. While it may be hard to claim the exception, it would still mean parallelism and the lower requirements for walls would be applied. It should be considered to have a higher class requirement for these spaces.

Limitations

The proposal of implementation of the new European classification system relates only to electric cables. Classification of associated installation components like cable trays, boxes, conduits etc is outside the scope of this project, and has not been dealt with.

8 Discussion

8.1 Current regulations in the Nordic countries

The current regulations for electric installations in the Nordic countries are based on the same international norms from IEC and CENELEC. These standards are to a large degree designed to avoid that a fire starting within the electrical system shall be able to spread in the cable insulation. The standards cover different flaming ignition sources, from a 1 kW to a 20.5 kW burner flame, and the extent of damaged material is measured. Smoke production is determined in a static 27 m³ chamber test using EN 61034-2

The new system of euroclasses for cables is based on the concept of reaction to fire, i.e. the product's behaviour when it is exposed to an external fire. Heat release and smoke production are measured using the same scientific basis and methods as for other types of construction products.

Results from basically all types of fire testing are highly dependent on the test method applied. It is therefore difficult, and even in some cases impossible to find correlations between results from two test methods because differences in the test set-up, geometry, fire exposure, measurements etc. affect the outcome of the test. The test standards referred to in regulations for electric installations and in the building regulations are significantly different in many aspects, and a correlation between results from these two systems is not possible to find without extensive testing and analysis.

Assuming that both systems give an acceptable level of fire safety for certain scenarios, it would be possible to require that cables should either satisfy euroclass X_{ca} or an analogous CENELEC- or IEC standard. For some scenarios, however, it may be necessary to require a certain euroclassification in the building regulations.

The system for reaction-to-fire classification for cables does not include requirements to other components in electrical systems, like cable trays and –ladders, boxes, enclosures, cable trunking and cable ducting systems etc. This should also be assessed when implementing the euroclasses for cables in the building regulations, to obtain an overall fire safe solution. The norms for electric installations also require documentation of fire properties for other components than cables, and these standards may be sufficient. However, there may be products in use today that do not fulfill the performance based requirements to fire safe construction products.

8.2 Fire statistics and experience

With regard to implementation of the new euroclasses for cables, the main question is how cables contribute in fire development, both regarding ignitability, heat release, flame spread and smoke production. Available fire statistics indicate that a small number of building fires start in cables, the share may be in the range of 1-2 % of all building fires. However, the statistical data is very sparse, and contains a large degree of uncertainty. The most thorough analysis of building fires with electrical cause in the Nordic countries was a study of Norwegian fire statistics, but the statistical data is not detailed enough to give a good status of how cables contribute by fire start and fire development. There is also some data from Denmark and Sweden, and a published paper from Finland, but the level of details is poor.

The reports from fires where cables were involved show that more of these fires led to large economical and practical consequences beyond the fire damage, because important functions like power distribution and data communication were affected. Considerable smoke production is also a common factor for these fires. However, the number of available reports material is not large, and the information may not be reliable in

some cases (e.g. information found from online newspapers). There is also a lack of information on how cables contribute in fires not caused by electric installations (i.e. how do cables contribute in "ordinary" building fires?).

8.3 Proposal of implementation of the cable classes

The classes in section 7.4 is a general proposal. However, it is possible to give more detailed guidelines for different applications and areas. According to our knowledge it is difficult to produce cables with no flaming droplets within a reasonable level of costs. For areas where it is assessed that flaming droplets is unacceptable, it is possible to add guidelines like

- cables should not be mounted in the ceiling (i.e. only on walls)
- cables mounted in the ceiling should be protected from below to stop flaming droplets from falling

Cables in the same bundle may be of different quality with regard to reaction to fire properties. It may be reasonable to allow one single cable in a bundle to be of a lower class than the others. However, there is no experimental data available to support an assessment of the effect of a deviation like this.

The guidelines may also advice that cables can be protected by a fire resistant construction thus allowing a lower class cable to be used.

8.4 Further research

This project has shown that there is very little information available on how electric cables in buildings contribute to fire safety. This is the case internationally, but also especially for the Nordic countries. It would therefore be useful if information about cables in fires was collected in the national fire statistics. However, we believe that this could be difficult to carry out, and that the uncertainty related to the collected information would be large. Another way to collect data on cables in fires would be to investigate a selection of building fires with the objective to analyse how cables contributed to the fire development.

The impact of reaction to fire exceptions with regards to orientation, surface areas, classifications etc. should also be investigated. There is not enough scientific basis to assess how a percentage rule would work in real fires.

Today's fire safety level for cables in the Nordic countries is a third area that should be focused on. It would be interesting to explore what amounts of cables that are installed in Nordic buildings today, what reaction to fire properties do they have, and what does this imply for the fire safety of different types of buildings? It should also be verified what classes today's cables satisfy in the new system. A start could be to investigate if the common cable types satisfy the proposed minimum safety level class E_{ca} .

An alternative solution to regulate fire properties of cables in buildings is to cover the cable installations with a protective construction or shield. How this kind of protection should be assessed is another subject that should be investigated.

References

1. Grayson, S., et al., *FIPEC, Fire Performance of Electric Cables - new test methods and measurement techniques*. 2000.
2. Journeaux, T., et al., *CEMAC - CE-marking of cables, SP Report 2010_27*. 2010, SP Technical Research Institute of Sweden: Borås.
3. Babrauskas, V., *Ignition Handbook: Principles and Application to Fire Safety Engineering, Fire Investigation, Risk Management and Forensic Science*. 2003: Fire Science Publishers.
4. Babrauskas, V. *How do electrical wiring faults lead to structure ignitions?* . in *Fire and Materials*. 2001. San Francisco, USA: Interscience communications Ltd.
5. Babrauskas, V., *Mechanisms and modes for ignition of low-voltage, PVC-insulated electrotechnical products*. *Fire and Materials*, 2006. **30**(2): p. 151-174.
6. Stricker, S., *Thermal Design of PVC-Insulated Heating Cable (Report 74-26-K)*. 1974, Ontario Hydro.
7. Ohtani, H. and K. Kawamura, *An Experimental Study on Thermal Deterioration of Electric Insulation of a PVC Attachment Plug*. *J. Japan Society for Safety Engineering*, 2003. **42**(4): p. 216-221.
8. Pizzo, Y., J.L. Consalvi, and B. Porterie, *A transient pyrolysis model based on the B-number for gravity-assisted flame spread over thick PMMA slabs*. *Combustion and Flame*, 2009. **156**(9): p. 1856-1859.
9. Torero, J.L., et al., *Estimation of a total mass transfer number from the standoff distance of a spreading flame*. *Combustion Science and Technology*, 2002. **174**(11-12): p. 187-203.
10. Consalvi, J.L., et al. *Diffusion flames upwardly propagating over PMMA: Theory, experiment and numerical modeling*. 2005.
11. Pagni, P.J. and T.M. Shih, *Excess pyrolyzate*. Symposium (International) on Combustion, 1977. **16**(1): p. 1329-1343.
12. Consalvi, J.L., B. Porterie, and J.C. Loraud, *A blocked-off-region strategy to compute fire-spread scenarios involving internal flammable targets*. *Numerical Heat Transfer, Part B: Fundamentals*, 2005. **47**(5): p. 419-441.
13. CENELEC, *EN 50399, Common test methods for cables under fire conditions - Heat release and smoke production measurements on cables during flame spread test - Test apparatus, procedures, results*. 2011, CENELEC.
14. Sundström, B., J. Axelsson, and P. Van Hees, *A proposal for fire testing and classification of cables for use in Europe. Report to the European commission and the fire regulators group*. 2003, SP Technical Research Institute of Sweden.
15. Breulet, H. and T. Steenhuizen, *Fire testing of cables: Comparison of SBI with FIPEC/Europacable tests*. *Polymer Degradation and Stability*, 2005. **88**(1): p. 150-158.
16. Mangs, J. and S. Hostikka. *Experiments and Numerical Simulations of Vertical Flame Spread on Charring Materials at Different Ambient Temperatures*. in *Fire Safety Science - Proceedings of the Tenth International Symposium*. 2011.
17. NUREG/CR-6850 EPRI/NRC-RES *Fire PRA Methodology for Nuclear Power Facilities, Volume 2: Detailed Methodology*. 2005, Electric Power Institute (EPRI) and U.S. Nuclear Regulatory Commission (NRC).
18. Nageshwar Rao, B., et al. *Heat release measurements on FRLS cables using cone calorimeter - CPRI's experience*. 2007.
19. Steen-Hansen, A., et al., *Elektriske kabler og brannrisiko. Brann tekniske egenskaper til kabler, ledningssystemer og kapslinger*. 2012, SINTEF NBL: Trondheim.
20. Passalacqua, R., et al., *Experimental characterisation of ITER electric cables in postulated fire scenarios*. *Fusion Engineering and Design*, 2013.
21. Alvares, N. and A.C. Fernandez-Pello, *Fire initiation and spread in overloaded communication system cable trays*. *Experimental Thermal and Fluid Science*, 2000. **21**: p. 51-57.
22. Isner, M.S., *Telephone switching station fire creates widespread emergency*. *Fire Journal*, 1990: p. 73-85.

23. Tewarson, A., J.L. Lee, and R.F. Pion, *Categorization of Cable Flammability, Part 1: Laboratory Evaluation of Cable Flammability EPRI NP-1200*. 1979. p. 5-6.
24. Fernandez-Pello, A.C., et al. *A study of the fire performance of electrical cables*. in *Third International Symposium on Fire Safety Science*. 1991.
25. Isaksson, S., *Påverkan av rök på elektronikk*. . 2000, SP Sveriges Provnings- och Forskningsinstitut: Borås.
26. Peacock, R., et al., *A Literature Review of the Effects of Smoke from a Fire on Electrical Equipment, NUREG/CR-7123*. 2012, U.S. Nuclear Regulatory Commission.
27. Breulet, H. *Smoke classification of cables: Better visibility in the European landscape?* 2005.
28. Sikkerhedsstyrelsen, *Statistik over elbrande 2010*. 2012.
29. Stensaas, J.P., *Branner på grunn av elektrisk installasjonsmaterieell*. 2007, SINTEF NBL: Trondheim.
30. Keski-Rahkonen, O. and J. Mangs, *FIRE INDUCED DAMAGE TO ELECTRICAL CABLES AND FIRE GROWTH ON CABLES*, in *Eurosafe 2002*. 2002, VTT: Berlin, Germany.
31. DSB, *Rapport. Brannårsaksstatistikk 2008*. 2009, Direktoratet for samfunnssikkerhet og beredskap: Tønsberg.
32. DSB, *Brann i kabelkultvert - Oslo Sentralstasjon 27.11.2007. Rapport*. 2008: Tønsberg, Norway.
33. Thoresen, S., *Oslo S - Brann lammer politiet. 2007-11-28* 2007, NRK Østfold [online].
34. digi.no, *Sårbart politi satt ut av kabelbrann. digi.no [online]*. 2007-11-28. 2007.
35. DSB and BE, *Granskningsrapport etter brannen i Bergseng bo- og servicesenter i Harstad den 18. Mars 2001*. . 2001: Tønsberg.
36. *Frognerbrannen - Ingen katastrofe*. Mot Brann, 1986. **8**(86).
37. NFPA, *Fire investigation summary. Rockefeller Center - High Rise Fire, Rockefeller Center, New York City, October 10, 1996*. 1996, National Fire Protection Association.
38. Engdahl, Ø., *Kabelbrann til 100 millioner i Tyssedal*. Brann & Sikkerhet, 1988. **88**(6-7).
39. Martikainen, R., *Pappersfabrik i Obbola utslagen av brand. 2007-01-25*. 2007, Expressen.se.
40. EU, *Council Directive 89/106/EEC of 21 December 1988 on the approximation of laws, regulations and administrative provisions of the Member States relating to construction products (89/106/EEC) (OJ L 40, 11.2.1989, p.12)*, EEC, Editor. 1989.
41. EU, *COMMISSION DECISION of 8 February 2000 on the procedure for attesting the conformity of construction products pursuant to Article 20 (2) of Council Directive 89/106/EEC as regards metal anchors for use in concrete for fixing lightweight systems 2000 a*.
42. EU, *COMMISSION DECISION of 3 May 2000 implementing Council Directive 89/106/EEC as regards the classification of the resistance to fire performance of construction products, construction works and parts thereof (2000/367/EC). Official Journal of the European Communities, L133/26, 6.6.2000*. 2000 b.
43. EU, *COMMISSION DECISION of 27 October 2006 amending Decision 2000/147/EC implementing Council Directive 89/106/EEC as regards the classification of the reaction-to-fire performance of construction products (2006/751/EC)*, E. Union, Editor. 2006.
44. CENELEC, *prEN 50575:2012 Power, control and communication cables – Cables for general applications in construction works subject to reaction to fire requirements*. 2012, CENELEC: Brussels, Belgium.
45. EU, *COMMISSION DECISION of 17 February 1997 on the procedure for attesting the conformity of construction products pursuant to Article 20 (2) of Council Directive 89/106/EEC as regards metal anchors for use in concrete for fixing lightweight systems 1997*.
46. EU, *COMMISSION DECISION of of 12 May 2011 on the procedure for attesting the conformity of construction products pursuant to Article 20(2) of Council Directive 89/106/EEC as regards power, control and communication cables 2011*.

47. EU, *DIRECTIVE 2006/95/EC OF THE EUROPEAN PARLIAMENT AND OF THE COUNCIL of 12 December 2006 on the harmonisation of the laws of Member States relating to electrical equipment designed for use within certain voltage limits* 2006.
48. EU, *GUIDELINES ON THE APPLICATION OF DIRECTIVE 2006/95/EC (ELECTRICAL EQUIPMENT DESIGNED FOR USE WITHIN CERTAIN VOLTAGE LIMITS)*. . 2007, European Commission services.
49. Sundström, B., *The Development of a European Fire Classification System for Building Products Test Methods and Mathematical Modelling*, in *Department of Fire Safety Engineering, Lund University*. 2007, Lund University: Lund.
50. CEN, *prEN 13501-6. Fire classification of construction products and building elements - Part 6: Classification using data from reaction to fire tests on electric cables*. . 2011, CEN: Brüssel.
51. Jensen, B., *E-mail dated 13.05.2013*. 2013.
52. Europacable_Norge, *Table presented by the Norwegian cable manufacturers in a CPR-project meeting in "Europacable-Norge"*. 2011: Oslo.
53. *Email communication between Michael Försth and Swedish cable manufacturers (Nexans, Telia, Draka, Ericsson) 2013-05-18*.
54. Energistyrelsen, *Bygningsreglementet 29.08.2011*. 2011, Energistyrelsen: København, Danmark.
55. Energistyrelsen, *Eksempelsamling om brandsikring af byggeri*. 2012, Klima-, Energi- og Bygningsministeriet, Energistyrelsen: København, Danmark.
56. Sikkerhedsstyrelsen, *Stærkstrømsbekendtgørelsen, afsnit 6*. 2001, Sikkerhedsstyrelsen.
57. EU. *A new approach to technical harmonisation*. 2011; Available from: http://europa.eu/legislation_summaries/internal_market/single_market_for_goods/technical_harmonisation/121001a_en.htm.
58. *Handels- och industriministeriets beslut om elanläggningsars säkerhet 17.12.1999/1193*. 1999.
59. *Tukes-anvisning, S10-2011, Standarder om elanläggningsars säkerhet och om säkerheten vid elarbeten*, Tukes, Editor. 2011, Tukes: Helsinki, Finland.
60. *Lågspänningsinstallationer. Del 4-42: Skyddsmetoder. Skydd mot termiska påverkningar*. 2012, Suomen standardisoimisliitto SFS: Helsinki, Finland.
61. Karlsson, B., *Personal communication with Björn Karlsson, Iceland Construction Authority*. 2013.
62. KR D, *Forskrift om tekniske krav til byggverk (Byggteknisk forskrift)*. , Kommunal og regionaldepartementet, Editor. 2010: Oslo.
63. DiBK, *Veiledning til Forskrift om tekniske krav til byggverk 2010*. , D.f. byggkvalitet, Editor. 2010: Oslo.
64. DiBK, *Regulations on technical requirements for building works (Technical Regulations) 2010*, Direktoratet for byggkvalitet: Oslo, Norway.
65. DSB, *Forskrift om elektriske lavspenningsanlegg. Direktoratet for samfunnssikkerhet og beredskap, Tønsberg, 1998*. . 1998, Direktoratet for samfunnssikkerhet og beredskap: Tønsberg.
66. NEK, *Norsk elektroteknisk norm. Elektriske lavspenningsinstallasjoner. 4. Utgave*. 2010, Norsk elektroteknisk komité (NEK): Oslo.
67. Thureson, P., et al., *The use of classification in the Nordic countries – Proposals for harmonisation*. ISBN 978-91-85829-46-0, ISSN 0284-5172. 2008, SP Sveriges Tekniska Forskningsinstitut: Borås.
68. Grav, J., *Information given in project workshop, Copenhagen*. 2013, Direktoratet for samfunnssikkerhet og beredskap.
69. Boverket, *Regelsamling för byggande, BBR 19. Del 2. Boverkets byggregler, BBR. 5 Brandskydd*. 2012, Boverket: Karlskrona, Sverige.
70. EU, *COMMISSION DECISION of 17 January 2003 establishing the classes of reaction-to-fire performance for certain construction products. (2003/43/EC)*, E. commission, Editor. 2003.

Appendix A: Classification of cables on the Norwegian market

| MAIN Product Family | Product Standard | Details | Fire performances | CPD |
|---------------------|---------------------|--|--|--------------|
| PN 750 V | EN 50525 | Single core interconnection wire | IEC 60332-1/EN 50265 | Eca |
| Downlight | EN 50525 | 90° double insulated twin conductor cable for downlights | IEC 60332-1/EN 50265 | Eca |
| PR 500V | NEK 535 | Screened cable for open building installations | IEC 60332-1/EN 50265 | Eca |
| PVXP and PFLP 250V | NEK 538 | Alarm cable | IEC 60332-1/EN 50265 | Eca |
| PFXP 500V | NEK | Duble insulated cable for building installations | IEC 60332-1/EN 50265 | Eca |
| PFXP 1kV | NEK-HD 603-3J | 1kV multi purpose power cable | IEC 60332-1/EN 50265 | Eca |
| PFSP 1kV | NEK-HD 603-3J | 1kV multi purpose power cable | IEC 60332-1/EN 50265 | Eca |
| PFSP 500 og 750V | NEK-HD 627 | Screened multi prpose signal cables | IEC 60332-1/EN 50265 | Eca |
| IX (H07Z1-R) | EN 50525 | "Halogen free" single core interconnection wire | IEC 61034/EN 50268, IEC 60754/EN 50267, IEC 60332-1/EN 50265 | Dca-s1 d2 a2 |
| I FLI 500V | NEK 591 | "Halogen free" screened cable for open building installations | IEC 61034/EN 50268, IEC 60754/EN 50267, IEC 60332-3/EN 50266 | Dca-s2 d2 a2 |
| I FLI 250V -R | NEK-HD 604, NEK 538 | "Halogen free" alarm cable | IEC 61034/EN 50268, IEC 60754/EN 50267, IEC 60332-3/EN 50266 | Dca-s2 d2 a2 |
| IFXI 500V | NEK | "Halogen free" double insulated cable for building installations | IEC 61034/EN 50268, IEC 60754/EN 50267, IEC 60332-1/EN 50265 | Dca-s2 d2 a2 |
| BI 500V | NEK | "Halogen free" and fire resistant, double insulated cable for building installations | IEC 61034/EN 50268, IEC 60754/EN 50267, IEC 60332-3/EN 50265, IEC 60331/EN 50200 | Dca-s2d2 a2 |
| IFSI 500 og 750V | NEK-HD 627 | "Halogen free", screened cable for open building installations | IEC 61034/EN 50268, IEC 60754/EN 50267, IEC 60332-1/EN 50265 | Dca-s2 d2 a2 |
| IFSI-EMC 1kV | NEK-HD 604-5D | "Halogen free" 1kV multi purpose power cable with EMC screen | IEC 61034/EN 50268, IEC 60754/EN 50267, IEC 60332-3/EN 50266 | Dca-s2 d2 a2 |
| BFSI-EMC 1kV | NEK-HD 604-5D | "Halogen free" and fire resistant 1kV power cable with EMC screen | IEC 61034/EN 50268, IEC 60754/EN 50267, IEC 60332-3/EN 50266, IEC 60331/EN 50200 | Dca-s2 d2 a2 |

| | | | | |
|---|--------|---|--|--------------|
| Other cables including PVC or other halogenated polymers for industrial use | IEC xx | Cables used in specific building areas, industry, equipment | IEC 60332-1/EN50265 | Eca |
| Other "halogen free" cables for industrial use | IEC yy | Cables used in specific building areas, industry, equipment | IEC 61034/EN 50268, IEC 60754/EN 50267, IEC 60332-1/EN 50265 | Dca-s2 d2 a2 |
| LAN/Data/fibre optic with halogenated polymers | IEC zz | Data transmission cables | IEC 60332-1/EN50265 | Eca |
| "Halogen free" LAN/Data/fibre optic | IEC ww | Data transmission cables | IEC 61034/EN 50268, IEC 60754/EN 50267, IEC 60332-1/EN 50265 | Dca-s2 d2 a2 |

Appendix B: Estimation of the exposed surface area of cables

One cable with an outer diameter D of 10 mm and a length L of 15 m, mounted against a wall is considered to be exposed from fire from one side:

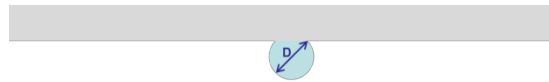

The exposed surface area may be approximated as: $A_{\text{exp}} = 0.01 \text{ m} \cdot 15 \text{ m} \cdot 1.5 = 0.225 \text{ m}^2$

5 cables with an outer diameter D of 10 mm and a length L of 15 m, with an air gap of 20 mm between the cables, all cables are situated against a wall:

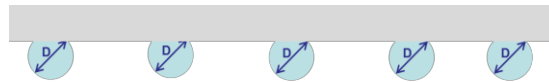

The exposed surface area may be approximated as: $A_{\text{exp}} = 0.01 \text{ m} \cdot 15 \text{ m} \cdot 1.5 \cdot 5 = 1.125 \text{ m}^2$

5 cables with an outer diameter D of 10 mm and a length L of 15 m, with no air gap between the cables, all cables are situated against a wall:

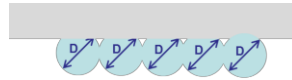

The exposed surface area may be approximated as: $A_{\text{exp}} = 0.01 \text{ m} \cdot 15 \text{ m} \cdot 1.5 \cdot 5 = 1.125 \text{ m}^2$

15 cables in 3 layers, 5 side by side, each with outer diameters D of 10 mm and a length L of 15 m, all cables are situated against a wall. 9 cables are then exposed:

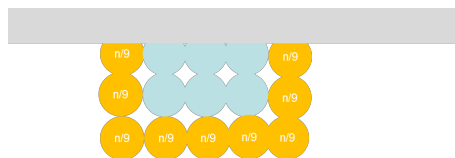

The exposed surface area may be approximated as: $A_{\text{exp}} = 0.01 \text{ m} \cdot 15 \text{ m} \cdot 1.5 \cdot 9 = 2.025 \text{ m}^2$

A cable with an outer diameter D of 10 mm and a length L of 15 m, situated on a cable ladder is considered to be exposed from all sides:



The exposed surface area may be approximated as: $A_{\text{exp}} = 0.01 \text{ m} \cdot 15 \text{ m} \cdot 3 = 0.45 \text{ m}^2$

5 cables with outer diameters D of 10 mm and a length L of 15 m, with an air gap of 20 mm between the cables, situated on cable ladder, is considered to be exposed from all sides:



The exposed surface area may be approximated as: $A_{\text{exp}} = 0.01 \text{ m} \cdot 15 \text{ m} \cdot 3 \cdot 5 = 2.25 \text{ m}^2$

5 cables with outer diameters D of 10 mm and a length L of 15 m, with no air gap between the cables, situated on cable ladder is considered to be exposed from all sides:

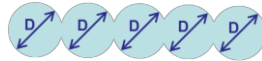

The exposed surface area may be approximated as: $A_{\text{exp}} = 0.01 \text{ m} \cdot 15 \text{ m} \cdot 3 \cdot 5 = 2.25 \text{ m}^2$

15 cables in 3 layers, 5 side by side, each with outer diameter D of 10 mm and a length L of 15 m, situated on a cable ladder where the inner cables are protected by the outer cables. In this case, twelve cables are considered to be exposed:

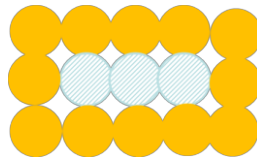

The exposed surface area may be approximated as: $A_{\text{exp}} = 0.01 \text{ m} \cdot 15 \text{ m} \cdot 1.5 \cdot 12 = 2.7 \text{ m}^2$



Technology for a better society

www.sintef.no